

# VACANZA<sup>®</sup> SERIES

2 0 1 5 O W N E R ' S M A N U A L



CalderaSpas<sup>®</sup>

# WELCOME



Watkins Manufacturing Corporation congratulates you on your decision to enjoy the finest spa available... Welcome to the growing family of Caldera® Spa owners.

## Owner's Manual

This Owner's Manual will acquaint you with the operation and general maintenance of your new Vacanza® series spa. We suggest that you take some time to carefully review all sections. Please keep this manual available for reference.

If you have any questions about any aspect of your spa's set-up, operation or maintenance, contact your authorized **CALDERA** dealership. They are trained professionals who are familiar with the product as well as new spa ownership concerns. Their expertise will facilitate the enjoyment of your new **CALDERA** spa.

The serial number/identification label is located within the equipment compartment of your **CALDERA** spa. The serial number should also be documented on the delivery receipt from your dealer.

**IMPORTANT:** Watkins Manufacturing Corporation reserves the right to change specifications, or design, without notification and without incurring any obligation.

DATE PURCHASED: \_\_\_\_\_

DATE INSTALLED: \_\_\_\_\_

DEALER: \_\_\_\_\_

ADDRESS: \_\_\_\_\_

TELEPHONE: \_\_\_\_\_

SPA MODEL/SERIAL NUMBER: \_\_\_\_\_

COVER SERIAL NUMBER: \_\_\_\_\_

MODEL: PALATINO  
SERIES: VACANZA  
SERIAL: PLT1T1001  
RATINGS: 240V, 60Hz, 40A



LISTED SELF CONTAINED SPA  
1280 Park Center Dr., Vista, CA 92081  
Watkins Manufacturing Corp.

PLT1T1001  
PLT1T1001  
PLT1T1001  
PLT1T1001  
PLT1T1001

**NOTE:** This is an example. Your spa's label will contain different information. Peel off top sticker and place here.

In most cities and counties, permits will be required for the installation of electrical circuits or the construction of exterior surfaces (decks and gazebos). In addition, some communities have adopted residential barrier codes which may require fencing and/or self-closing gates on the property to prevent unsupervised access to a pool (or spa) by children under 5 years of age. Your **CALDERA** spa is equipped with a locking cover that meets the ASTM F1346-91 Standard for Safety Covers, and as a result, is usually exempt from most barrier requirements. As a general practice, your local Building Department will inform you of any applicable barrier requirements at the time a permit is obtained for the installation of an electrical circuit. Your **CALDERA** dealer can provide information on which permits may be required.

# TABLE OF CONTENTS

## SAFETY INSTRUCTIONS

- Important Safety Instructions ..... 1
- Important Spa Instructions ..... 3

## INSTALLATION

- Site and Selection Preparation ..... 3
- Outdoor and Patio Installation ..... 3
- Deck Installation ..... 4
- Indoor/Basement Installation ..... 4
- Spa Leveling Preparation ..... 4
- Spa Cover Installation ..... 4

## ELECTRICAL INSTALLATION

- Selecting the Voltage for Your Spa ..... 5
- 115-230 Volt Conversion (Tarino™ & Aventine®) ..... 5
- 230 Volt Wiring Instructions (Palatino®, Marino® & Vanto®) ..... 6

## START-UP AND REFILL PROCEDURES

- Start-up and Refill Procedures ..... 7

## SPA FEATURES

- **PALATINO** ..... 9
- **MARINO** ..... 9
- **VANTO** ..... 10
- **TARINO** ..... 10
- **AVENTINE** ..... 11

## JET MENUS

- **PALATINO** ..... 12
- **MARINO** ..... 12
- **VANTO** ..... 13
- **TARINO** ..... 13
- **AVENTINE** ..... 14

## OPERATING INSTRUCTIONS

- Control Operation ..... 15
- System Mode ..... 16
- Manual Clean Cycle ..... 16
- Tools Menu ..... 16
- Audio Menu (Optional) ..... 18
- Air Control ..... 20
- Hydrotherapy Jets ..... 20
- Waterfall Valve ..... 20

## WATER QUALITY AND MAINTENANCE

- Water Terminology ..... 21
- General Information ..... 21
- Methods for Testing the Spa Water ..... 22
- The Watkins Spa Water Maintenance Program ..... 23
- FROG® Water Care System ..... 24
- Monarch® Ozone System ..... 27
- Spa Water Maintenance Troubleshooting Guide ..... 28
- Common Water Chemistry Questions ..... 29

## MAINTENANCE

- Filter Maintenance ..... 29
- Care of the Spa Pillows ..... 30
- Care of the Exterior ..... 30
- Care of the Spa Cover ..... 30
- EcoTech® Spa Cabinet ..... 31
- Draining Your Spa ..... 31
- Non-Operation in Cold Climate ..... 31
- Winterizing Your Spa ..... 31

## SERVICE

- Acts Invalidating Warranty ..... 32
- Disclaimers ..... 32
- Watkins Customer Service ..... 32

## SPA TROUBLESHOOTING

- Troubleshooting ..... 33
- Priming the Pumps ..... 34
- Limited Warranty ..... 35

## SPA SPECIFICATIONS ..... Back Cover

# SAFETY INFORMATION

## IMPORTANT SAFETY INSTRUCTIONS

### READ AND FOLLOW ALL INSTRUCTIONS

### AVOIDING THE RISK TO CHILDREN

#### **DANGER:**

- **RISK OF CHILD DROWNING.** Extreme caution must be exercised to prevent unauthorized access by children. To avoid accidents, ensure that children cannot use a spa unless they are supervised at all times.

#### **WARNING:**

- To reduce the risk of injury, do not permit children to use this product unless they are closely supervised at all times.
- To reduce the risk of injury, lower water temperatures are recommended for young children. Children are especially sensitive to hot water.

#### **DO:**

- Make sure you always lock the child resistant locks after using the spa for your children's safety. Every **CALDERA** spa is equipped with a locking cover that meets the ASTM F1346-91 Standard for Safety Covers.
- Test the water temperature with your hand before allowing your child to enter the spa to be sure that it's comfortable. Children are especially sensitive to hot water.
- Remind children that wet surfaces can be very slippery. Make sure that the children are careful when entering or exiting the spa.

#### **DON'T:**

- Allow children to climb onto the spa cover.
- Allow children to have unsupervised access to the spa.

### AVOIDING THE RISK OF ELECTROCUTION

#### *Risk of electrocution*

- Connect only to a grounded source.
- Do not bury the power cord. A buried power cord may result in death or serious personal injury due to electrocution if direct burial-type cable is not used, or if improper digging occurs.
- A ground terminal (pressure wire connector) is provided on the control box inside the unit to permit connection of a minimum No. 10 AWG solid copper bonding conductor between this point and any metal equipment, metal water pipe, metal enclosures of electrical equipment, or conduit within five feet (1.5 m) of the unit as needed to comply with local requirements.

#### **WARNING:**

- To reduce the risk of electrical shock, replace a damaged cord immediately. Failure to do so may result in death or serious personal injury due to electrocution.
- Your spa is provided with a Ground Fault Circuit Interrupter for user and equipment protection. To ensure proper operation of this important safety device, test according to the following instructions per electrical configuration.

**Cord-Connected 115 volt, 20 amp models:** The GFCI is located at the end of the power cord. Before each use, with the unit operating, push the TEST button. The unit should stop operating and the GFCI power indicator will go out. Wait 30 seconds and then reset the GFCI by pushing the RESET button. The GFCI power indicator will turn on, restoring power to the spa. If the interrupter does not perform in this manner, there may be an electrical malfunction and with it, the possibility of an electric shock. Disconnect the power until the problem has been corrected. **NOTE: This will reset the filter cycle.**

**230 volt, permanently installed or converted models:**

- A ground terminal is provided on the terminal block located inside the control box. To reduce the risk of electric shock, connect this terminal to the grounding terminal of your electrical service or supply panel with a continuous green, insulated copper wire. The wire must be equivalent in size to the circuit conductors supplying the equipment. In addition, a bonding terminal (pressure wire connector) is provided on the outside of the control box for bonding to local ground points. To reduce the risk of electric shock, this connector should be bonded with a No. 10 AWG solid copper wire to any metal ladders, water pipes, or other metal within 5 feet (1.5 m) of the spa to comply with local requirements. The means of disconnection must be readily accessible, but must be installed at least 5 feet (1.5 m) from the spa.
- Your spa is provided with a suitably rated circuit breaker to open all ungrounded supply conductors.
- Your spa uses ground fault circuit interrupters in the electrical subpanel. Before each use of the spa and with the unit operating, push the Test button on the breaker. The switch should click over to the "Trip" position. Wait 30 seconds and reset the GFCI breaker by switching it completely off and then completely on. The switch should then stay on. If either of the interrupters does not perform in this manner, it is an indication of an electrical malfunction and the possibility of an electric shock. Disconnect the power until the fault has been identified and corrected. **NOTE: This will reset the filter cycle.**

# SAFETY INFORMATION

## **DANGER: RISK OF ELECTRICAL SHOCK**

- Install spa at least 5 feet (1.5 m) from all metal surfaces. A spa may be installed within 5 feet of a metal surface if each metal surface is permanently connected by a minimum No. 10 AWG solid copper conductor attached to the wire ground connector on the terminal box that is provided for this purpose if in accordance with National Electrical Code ANSI/NMFA70-1993.
- Do not permit any electrical appliances, such as a light, telephone, radio, or television within 5 feet (1.5 m) of a spa. Failure to maintain a safe distance may result in death or serious personal injury due to electrocution if the appliance should fall into the spa.
- Install your spa in such a way that drainage is away from the electrical compartment and from all electrical components.

## **DO:**

- Be sure your spa is connected to the power supply correctly - use a licensed electrical contractor.
- Disconnect the spa from the power supply before draining the spa or servicing the electrical components.
- Test the Ground Fault Circuit Interrupter(s) before each use.

## **DON'T:**

- Use the spa with the equipment compartment door removed.
- Place electrical appliances within 5 feet (1.5m) of the spa.
- Use an extension cord to connect the spa to its power source. The cord may not be properly grounded and the connection is a shock hazard. An extension cord may cause a voltage drop, which will cause overheating of the jet pump motor and motor damage.
- Attempt to open the electrical control box. There are no user serviceable parts inside.

## **RISKS TO AVOID**

### **DANGER: RISK OF INJURY**

- DO NOT sit in the filter compartment area. Sitting in this area can cause: a) Restriction of Filter Pump suction/vacuum b) Damage to components Both can result in bodily harm. Should damage occur to components in this area, replace immediately!
- To reduce the risk of injury to persons, DO NOT remove floating weir, basket, and filter located in the filter compartment while the spa is running.
- The suction fittings in the spa are sized to match the specific water flow created by the pump. Never replace a suction fitting with one rated less than the flow rate marked on the original suction fitting.
- There is a danger of slipping and falling. Remember that wet surfaces can be very slippery. Take care when entering or exiting the spa.
- Never operate spa if the suction fittings are broken or missing.
- People with infectious diseases should not use the spa.
- Keep any loose articles of clothing or hanging jewelry away from rotating jets or other moving components.

### **Increased side effects of medication**

- The use of drugs, alcohol or medication before or during spa use may lead to unconsciousness with the possibility of drowning.
- Persons using medications should consult a physician before using a spa; some medication may cause a user to become drowsy, while other medication may affect heart rate, blood pressure, and circulation.
- Persons taking medications which induce drowsiness, such as tranquilizers, antihistamines or anticoagulants should not use the spa.

### **Health problems affected by spa use**

- Pregnant women should consult a physician before using spa.
- Persons suffering from obesity or with a medical history of heart disease, low or high blood pressure, circulatory system problems, or diabetes should consult a physician before using spa.

### **Unclean water**

- Keep the water clean and sanitized with correct chemical care. The recommended levels for your **CALDERA** spa are:

Bromine:	1.0 - 2.0 ppm with <b>FROG</b> water care system (3-5 ppm if not using <b>FROG</b> )	Total Alkalinity:	40 - 120 ppm
Water pH:	7.2 - 7.8	Calcium Hardness:	50- 150 ppm

(Refer to Water Quality and Maintenance section for complete instructions.)

**IMPORTANT:** Turn jet pump on for at least ten minutes after adding ANY spa water chemicals into the filter compartment.

- Clean the filter cartridge monthly to remove debris and mineral buildup which may affect the performance of the hydromassage jets, limit the flow, or trip the high-limit thermostat which will turn off the entire spa.

## **AVOIDING THE RISK OF HYPERTHERMIA**

Prolonged immersion in hot water can result in HYPERTHERMIA, a dangerous condition which occurs when the internal temperature of the body reaches a level above normal (98.6°F, 37°C). The symptoms of hyperthermia include unawareness of impending hazard, failure to perceive heat, failure to recognize the need to exit the spa, physical inability to exit the spa, fetal damage in pregnant women, and unconsciousness resulting in a danger of drowning.

# SAFETY INFORMATION

## **WARNING:**

The use of alcohol, drugs, or medication can greatly increase the risk of fatal hyperthermia in hot tubs and spas.

## **TO REDUCE THE RISK OF INJURY:**

- The water in the spa should never exceed 104°F (40°C). Water temperatures between 100°F (38°C) and 104°F (40°C) are considered safe for a healthy adult. Lower water temperatures are recommended for extended use (exceeding 10 minutes) and for young children. Extended use can cause hyperthermia.
- Pregnant or possibly pregnant women should limit spa water temperatures to 100°F (38°C). Failure to do so may result in permanent injury to your baby.
- Do not use spa immediately following strenuous exercise.

## **AVOIDING THE RISK OF SKIN BURNS:**

- To reduce the risk of injury, before entering a spa the user should measure the water temperature with an accurate thermometer.
- Test the water with your hand before entering the spa to be sure it's comfortable.

## **SAFETY SIGN**

Each **VACANZA** series spa is shipped with a SAFETY SIGN in the owner's package. The sign, which is required as a condition of Product Listing, should be permanently installed where it is visible to the users of the spa. To obtain additional SAFETY SIGNS, contact your **CALDERA** dealer and request Part #33869.

## **IMPORTANT SPA INSTRUCTIONS**

The following contains important spa information, and we strongly encourage you to read and apply them.

### **DO:**

- Use and lock the vinyl cover when the spa is not in use, whether it is empty or full.
- Follow the Spa Care and Maintenance recommendations stated in this manual.
- Use only approved accessories and recommended spa chemicals and cleaners.

### **DON'T:**

- Leave the spa exposed to the sun without water or the vinyl cover in place. Exposure to direct sunlight can cause solar distress of the shell material.
- Roll or slide the spa on its side. This will damage the siding.
- Lift or drag the cover by using the cover lock straps; always lift or carry the cover by using the handles.
- Attempt to open the electrical control box. There are no user serviceable parts inside. Opening of the control box by the spa owner will void the warranty. If you have an operational problem, carefully go through the steps outlined in the Troubleshooting section. If you are not able to resolve the problem, contact your authorized **CALDERA** dealer. Many problems can easily be diagnosed over the telephone by an Authorized Service Technician

# INSTALLATION

## **SITE AND SELECTION PREPARATION**

You probably have a spot picked out for your new spa, whether it's indoors or outdoors, on a patio or on a deck. Just make sure you check the following:

- Always put your spa on a structurally sound, level surface. A filled spa can weigh a great deal. Make certain that the location you choose can support the weight of your filled spa.
- Don't forget to level your spa before filling it (see the Spa Leveling Preparation section on the next page).
- Locate your equipment compartment, which houses all of the electrical components, in a place where water will drain away from it. Allowing water into the equipment compartment can damage the electronics, or may result in tripping your house's circuit breaker.
- Leave yourself easy access to the Ground Fault Circuit Interrupter (GFCI) for testing. The GFCI is located at the end of the power cord, or at the subpanel of a hard-wired spa.
- Never let water get into the subpanel or into the electrical outlet that your spa is plugged into. Consult your local code authority to determine if an electrical outlet with a cover is required for your installation.
- Leave access to the equipment compartment for periodic spa care and maintenance.

 **WARNING: Damage to the spa's equipment compartment components or internal plumbing as a result of rodent infestation is NOT covered under your warranty!**

## **OUTDOOR AND PATIO INSTALLATION**

No matter where you install your new spa, it's important that you have a solid foundation to support it. Structural damage to the spa, resulting from incorrect installation or placement on an inadequate foundation, is not covered under the spa's limited warranty.

If you install the spa outdoors, we recommend a reinforced concrete pad at least four inches thick. The reinforcing rod or mesh in the pad should be attached to a bond wire.

# INSTALLATION

## DECK INSTALLATION

To be certain your deck can support your spa, you must know the deck's maximum load capacity. Consult a qualified building contractor or structural engineer. To find the weight of your spa, its contents and occupants, refer to the Spa Specifications chart on the back cover. This weight per square foot must not exceed the structure's rated capacity, or serious structural damage could result.

## INDOOR/BASEMENT INSTALLATION

Be aware of some special requirements if you place your spa indoors. Water will accumulate around the spa, so flooring materials must provide a good grip when wet. Proper drainage is essential to prevent a build-up of water around the spa. When building a new room for the spa it is recommended that a floor drain be installed. The humidity will naturally increase with the spa installed indoors. Water may get into woodwork and produce dry rot, mildew, or other problems. Check for the effects of airborne moisture on exposed wood, paper, etc. in the room. To minimize these effects, it is best to provide plenty of ventilation to the spa area. An architect can help to determine if more ventilation must be installed.

Your **CALDERA** spa dealer can help you with local information such as zoning regulations and building codes.

**⚠ WARNING: Please keep the area around your spa well ventilated when it is installed indoors or in a confined area.** Inadequate ventilation around the spa could cause a build-up of a higher-than-normal concentration of spa chemicals and/or bacterial fragments. These dispersed spa chemicals and/or bacterial fragments can be inhaled, and may result in breathing difficulties or lung damage in certain people suffering from a compromised immune system or respiratory infection. If you or other bathers are affected by this condition, please seek medical attention as soon as possible.

In addition to the above, properly clean and maintain your spa as follows:

- Follow all procedures in this owner's manual and printed instructions on all water care (chemical) products packaging.
- Test the water regularly to ensure proper levels of sanitizers, pH, and other water care requirements.
- Drain, clean, and refill your spa with fresh water on a regular schedule, and in accordance with this owner's manual.
- Clean the filter(s) at least once per month.
- Check to make sure you have proper circulation throughout your spa water system.
- Have spa users bathe before entering the spa water.

## SPA LEVELING PREPARATION

Concrete sloped at  $\frac{1}{2}$  inch (1.3 cm) per 10 feet (305 cm) is preferred so that rain water and water spillover will run off and not puddle underneath the spa (water under the spa for long periods of time may cause the wood to deteriorate). Other options are brick, stepping stone, or blocks.

It is important to note that soft surfaces, even when stepping stones are used to evenly distribute the weight of the spa, will have a tendency to settle, thus resulting in an unlevelled spa.

**NOTE:** Placing the spa on grass or dirt may increase the amount of debris which is inadvertently brought into the spa water and may cause harm to your equipment as well as the spa surface, which is not covered under warranty.

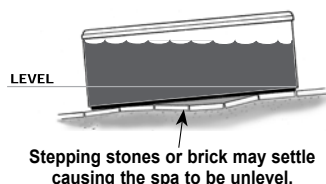
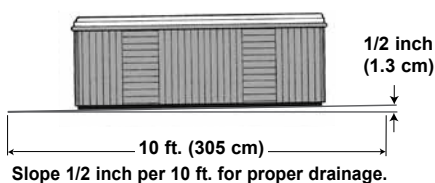

## SPA COVER INSTALLATION

- Place the cover squarely on the spa.
- Position the tie-down locks included with your cover on the side of the spa so that they are easily reached by the cover tie-down straps. Allow for about  $\frac{1}{2}$  inch to  $\frac{3}{4}$  inch (1.3 cm to 1.9 cm) slack in the straps to make it easy to insert straps into locks and to compensate for vinyl shrinkage in cold weather.
- Attach the locks with the screws provided and insert the cover tie-down straps into the locks.

**NOTE:** Keeping the cover in place any time the spa is not in use will reduce the amount of time the heater operates, thereby minimizing operating costs.

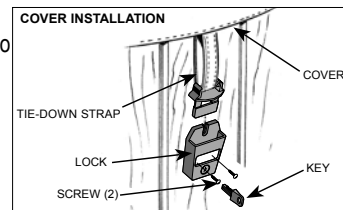

### **DANGER. RISK OF INJURY.**

- **Never leave a spa uncovered or unattended.**
- **Never leave a spa cover unlocked.**
- **Do not stand, sit, or lie on the cover.**

# ELECTRICAL INSTALLATION

## SELECTING THE VOLTAGE FOR YOUR SPA

The **TARINO** and **AVENTINE** spas are designed to operate at either 115 volt 20 amp or 230 volt 50 amp while the **PALATINO**, **MARINO** & **VANTO** spa models require a dedicated 230 volt 50 amp power supply. When the **TARINO** or **AVENTINE** spa is connected to 115 volts 20 amp, the heater will provide approximately 1000 watts of heat only when the pump is operating in LOW speed and the thermostat is calling for heat (NOTE: The heater does not operate when the pump is on high speed). When the **PALATINO**, **MARINO**, **VANTO**, **TARINO** and **AVENTINE** spas are connected to 230 volts, the heater will provide approximately 4000 watts of heat when the pump is operating in LOW or HIGH speed and the thermostat is calling for heat.

All electrical connections must be made in accordance with the wiring information contained in the electrical control box or on the back of the field wiring access panel of the equipment module.

### 115 VOLT INSTALLATION

Spas provided with a factory-installed power supply cord are to be plugged into a grounded, grounding type 20 ampere receptacle (**TARINO** & **AVENTINE**) models. No other electrical appliance or fixture can be used on this circuit.

**IMPORTANT:** Under **NO** circumstances should an extension cord be used. Use of an extension cord will seriously degrade the performance of the equipment module and can create an electrical hazard.

### 230 VOLT INSTALLATION

When using 230 volt power supply, installation of a 50 amp dedicated circuit is required. Your spa must be hardwired direct to a GFCI-protected subpanel by a licensed electrician. A wiring diagram is provided inside the equipment module showing where the connections are to be made.

## ELECTRICAL REQUIREMENTS AND PRECAUTIONS

Your **VACANZA** series spa has been carefully designed to give you maximum safety against electrical shock. Connecting the spa to an improperly wired circuit will negate many of the spa's safety features. Improper wiring may also cause electrocution, risk of fire, and other risks of injuries. Please read and follow the electrical installation requirements and instructions for your spa completely!

## 115-230 VOLT CONVERSION (TARINO & AVENTINE SPA MODEL)

Refer to the following instructions to convert your 115 volt **TARINO** or **AVENTINE** spa to a 230 volt 30A or 50A spa.

**NOTE:** Converting the spa to 230 volts operation should only be done by an authorized service agent or a qualified electrician. A **CALDERA** Spa Technician must reconfigure spa using the soft jumpers to allow the heater to run at 4K, and the jet pump Not to run concurrent with heater @ 30A and run concurrent with heater @ 50A.

The conversion requires a subpanel (230 volt) which may be purchased from your Authorized dealer. Ask for part # 301758.

1. Disconnect the power cord from the house receptacle.
2. Remove the screws and open the equipment compartment door.
3. Remove the screws from the control box.
4. Open the control box cover.
5. Remove the power cord wires, and the power jumper wire (from line 2 and neutral) on the line side of the terminal block.

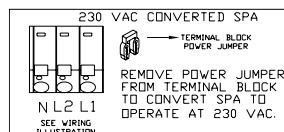

A licensed electrician must install the subpanel (available from your dealer) to supply power to the spa. The subpanel must be placed in sight of the spa at a minimum distance of 5 feet away. All electrical connections must be made in accordance with the wiring information contained in this manual and on the back of the field wiring access panel of the control box. **NOTE:** Bond the spa to all exposed metal equipment or fixtures, handrails, and concrete pad per N.E.C. and all local codes.

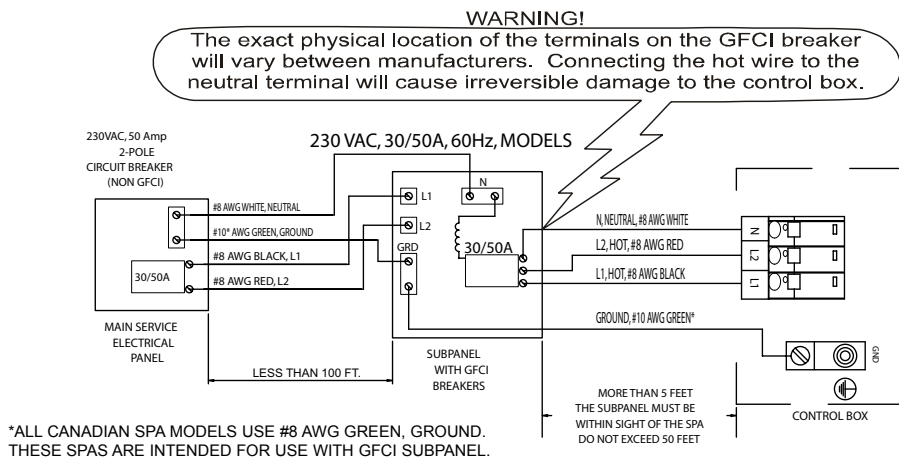



# ELECTRICAL INSTALLATION

## 230 VOLT 30A OR 50A WIRING INSTRUCTIONS (PALATINO, MARINO & VANTO SPA MODELS)

**NOTE:** The subpanel must be placed within 100 feet (30.5 m) of the main electrical service panel, and between 5 feet (1.5 m) and 50 feet (15 m) away from the spa. All electrical connections must be made in accordance with the wiring information contained in this manual and on the back of the field wiring access panel of the control box. When using a 30A configuration, a **CALDERA** Spa Technician must reconfigure spa using the soft jumpers to run heater at 4000K but Not run concurrent with the jet pump.

Refer to the wiring diagram below.

1. Connect the #8 AWG, WHITE [NEUTRAL] wire from the Neutral/Ground Bar on the main electrical service to the WHITE [NEUTRAL, Panel Neutral, Pigtail] of the subpanel.
2. Connect the #8 AWG, BLACK [L1] wire from the main electrical service to the subpanel [terminal L1].
3. Connect the #8 AWG, RED [L2] wire from the main electrical service to the subpanel [terminal L2].
4. Connect the #10 AWG, GREEN wire from the Neutral/Ground Bar on the subpanel GRD.
5. Connect the #8 AWG, WHITE [NEUTRAL] wire from the subpanel to the Neutral terminal on the spa's control box.
6. Connect the #8 AWG, BLACK [L1] wire from the subpanel breaker to terminal [L1] on the spa's control box.
7. Connect the #8 AWG, RED [L2] wire from the subpanel breaker to terminal [L2] on the spa's control box.
8. Connect the #10 AWG, GREEN wire from the subpanel GRD to the GROUND terminal of the spa's control box.
9. Bond the spa to all exposed metal equipment or fixtures, handrails, and concrete pad per N.E.C. and all local codes.
10. If converting to 30A a **CALDERA** Spa Technician must reconfigure spa using the soft jumpers to remove the heater from running concurrent with jet pump.

### WARNING!

The exact physical location of the terminals on the GFCI breaker will vary between manufacturers. Connecting the hot wire to the neutral terminal will cause irreversible damage to the control box.

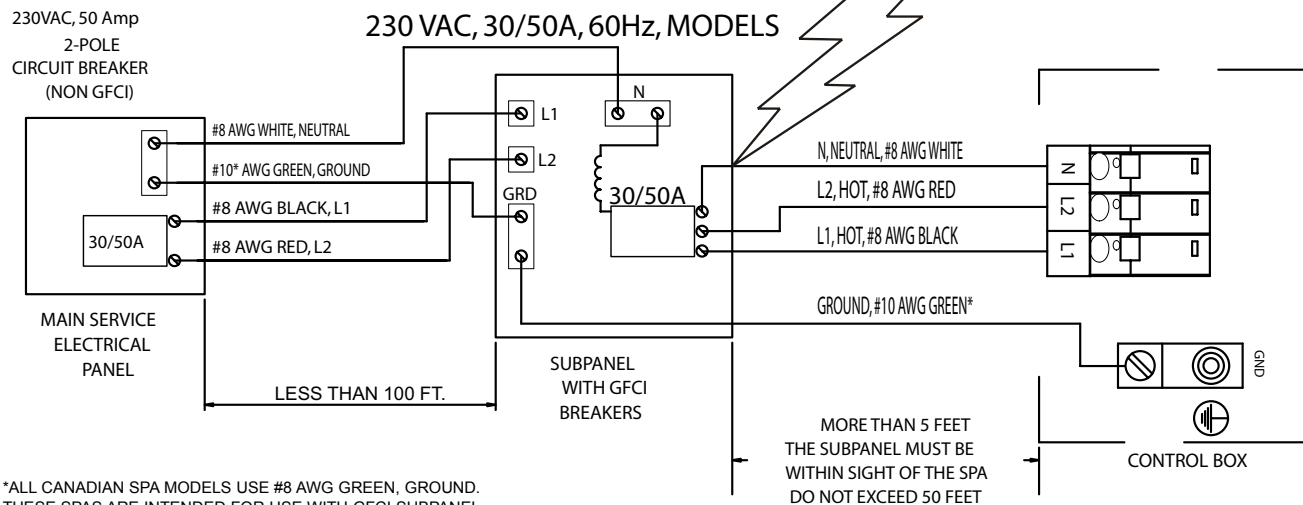

\*ALL CANADIAN SPA MODELS USE #8 AWG GREEN, GROUND. THESE SPAS ARE INTENDED FOR USE WITH GFCI SUBPANEL PROVIDED.

# START-UP AND REFILL PROCEDURES

## START-UP AND REFILL PROCEDURES

Your **VACANZA** series spa has been thoroughly tested during the manufacturing process to ensure reliability and long-term customer satisfaction. A small amount of water may have remained in the plumbing after testing and, as a result, may have spotted the spa shell or the spa siding prior to delivery. Before filling the spa, wipe the spa shell clean with a soft rag. The following instructions must be read and followed exactly to ensure a successful start-up or refill.

### CAUTIONS

- **Do not fill the spa with hot water**, as tripping of the high-limit thermostat may result.
  - **DO NOT CONNECT POWER TO AN EMPTY SPA.** Power to the spa automatically activates critical components within the spa, such as controls, heater, and other systems. If power is supplied to these components prior to the spa being filled, the components will be damaged, and this may result in a non-warranty component failure.
  - **DO NOT** use your spa after filling until all of the steps listed below are completed.
  - **DO NOT** add chlorine if treating your spa with polyhexamethylene biguanide (Biguanide, PHMB, eg. BaquaSpa®) sanitizer.
  - Before filling your spa for the first time, remove the equipment compartment door and check to ensure that the unions on either side of the pump(s) and heater are hand-tight.
1. **CLOSE ALL DRAINS, remove the filter.** Fill your spa through the filter compartment using the CleanScreen™ pre-filter attached to your garden hose. The water level of your **VACANZA** series spa should be maintained at a level one inch above the highest jet in the spa. Reinstall the filter and then the skimmer basket, and weir once the spa is filled.  
**IMPORTANT:** *Watkins Manufacturing Corporation does not recommend that the spa be filled with "softened" water, as this may damage the spa's equipment.*
  2. **AFTER THE SPA HAS BEEN FILLED** with water and the equipment compartment door is secured, power must be applied to the spa.
    - **115 volt model:** Connect the GFCI to the waterproof receptacle and push the RESET button on the GFCI.
    - **230 volt models:** Open the door of the electrical subpanel and reset the GFCI breaker. Close and secure the subpanel door.
  3. **TO CHECK THE OPERATION OF THE JET SYSTEM** and to purge any remaining air from the heating system, push the "JETS" button on the control panel three times (twice for **TARINO & AVENTINE** models) to run the jet pump(s) on high speed for one minute. Once the jet system is fully operational (as indicated by strong, non-surfing jets), priming of the spa is complete. If you do not feel a steady stream of water from your jets, refer to the instructions for priming the pump in the SPA TROUBLESHOOTING section in the back of this manual.
  4. **SET THE TEMPERATURE CONTROL** to the desired temperature between 100°F (38°C) and 104°F (40°C), then place the spa cover on the spa and allow the water temperature to stabilize (approximately 24 hours). Make sure you secure the cover in place using the cover locks. Periodically check the spa water temperature. When the water temperature climbs above 90°F (32°C), proceed to the next step. The spa temperature is pre-programmed to reach 100 F (38°C), and will normally do so within 18 to 24 hours.
  5. **USING A TEST STRIP AND APPLICABLE CHEMICALS** adjust Total Alkalinity (TA) to 80-180 ppm, Calcium Hardness (CH) to 50-150 ppm, then spa water pH to between 7.2 and 7.8. These procedures are listed in the "Water Quality and Maintenance" section.  
**OPERATION NOTE:** *Adjusting the Total Alkalinity as the first step is important, as out-of balance TA will affect your ability to adjust the pH correctly and will prevent the sanitizer from operating effectively.*  
**IMPORTANT:** *Activate the Clean cycle before adding spa water chemicals directly into the filter compartment.*
  6. Add Metal remover if metals are in water. Wait 24 hours before adding **FROG**
  7. **INSTALL FROG bromine and mineral cartridges.** When spa reaches operating temperature, dial the mineral cartridge to setting 6 and snap into the top space of the cartridge holder. Dial the bromine cartridge to the appropriate setting based on the chart below and snap into the bottom space of the cartridge holder.

Spa Size (gallons)	250-300	300-400	400-500
Bromine Setting	2	2	3

**WARNING:** *High sanitizer levels can cause discomfort to the user's eyes, lungs and skin. Always allow the sanitizer level to fall to the recommended range before using the spa.*

**IMPORTANT:** *Each time the spa is filled with water, you must remove and reinstall the **FROG** cap, even if you are not replacing the cartridge, in order to properly prime the jet pumps.*

8. **Recheck the Total Alkalinity (TA) 40-120 ppm, Calcium Hardness (CH) 50-150 ppm, then spa water pH at between 7.2 and 7.8.**

**OPERATION NOTE:** Make sure you adjust your Total Alkalinity first, as an out-of-balance condition will affect your ability to adjust the pH correctly, and will affect the sanitizers effectiveness.

The spa is ready for use when the bromine level remains between 1-ppm and 2-ppm.

# START-UP AND REFILL PROCEDURES

## OPERATION NOTES:

1. Your spa is equipped with a ten-minute timer delay on the heating/tranquil mode. Whenever the jet pump has been turned off (and a demand for heat has occurred) or the temperature control has been turned up, it will take ten minutes before the low speed of the jet pump and heater become activated. Always push the "JETS" button to turn off the jet pump when exiting the spa. In the standard 115 volt, 20 amp electrical configuration, the heating system does not operate simultaneously with the high speed pump. On the other hand, on the 230-volt system, the heating system does operate simultaneously with the high speed pump.
2. The spa controller has an automatic one-hour "time-out" feature should the high speed jet mode be left on inadvertently. **After one hour of continuous operation, the controller will automatically return to the maintenance/heating mode.**
3. The spa controller also has a six-hour "time-out" feature should the light be left on inadvertently. **After six hours of continuous operation, the controller will automatically turn the light off.**

# SPA FEATURES

## PALATINO

1. Air control
2. Spa-side control panel
3. Filter compartment\*
4. Temperature sensor
5. Drain /suction fitting
6. Outlet for optional ozone
7. AdaptaFlo® jets
8. AdaptaSsage® jets
9. Euro Directional jets
10. Pillow
11. Waterfall valve
12. Acquarella® Waterfall
13. **FROG**



**\* WARNING: DO NOT SIT IN THE FILTER COMPARTMENT AREA "THIS IS NOT A SEAT"!!!**

Sitting in this area can cause:

- Restriction of filter pump suction/vacuum.
- Damage to components.

Both can result in bodily harm.

Should damage occur to components in this area, replace immediately!

## MARINO

1. Air control
2. Spa-side control panel
3. Filter compartment\*
4. Temperature sensor
5. Euro Directional jets
6. **ADAPTAFLO** jets
7. **ADAPTASSAGE** jets
8. Outlet for optional ozone
9. Drain/suction fitting
10. Pillow
11. Waterfall valve
12. **ACQUARELLA** waterfall
13. **FROG**



# SPA FEATURES

## VANTO

1. Air control
2. Spa-side control panel
3. Filter compartment\*
4. Temperature sensor
5. Euro Directional jets
6. **ADAPTAFLO** jets
7. **ADAPTASSAGE** Jets
8. Outlet for optional ozone
9. Drain/suction fitting
10. Pillow
11. Waterfall valve
12. **ACQUARELLA** Waterfall
13. **FROG**

**\* WARNING: DO NOT SIT IN THE FILTER COMPARTMENT AREA "THIS IS NOT A SEAT"!!!**

Sitting in this area can cause:

- Restriction of filter pump suction/vacuum.
- Damage to components.

Both can result in bodily harm.

Should damage occur to components in this area, replace immediately!



## TARINO

1. Air control
2. Spa-side control panel
3. Filter compartment\*
4. Temperature sensor
5. Euro Directional jets
6. **ADAPTAFLO** jets
7. **ADAPTASSAGE** Jets
8. Outlet for optional ozone
9. Drain/suction fitting
10. Pillow
11. **ACQUARELLA** Waterfall
12. Waterfall valve
13. **FROG**
14. Diverter



# SPA FEATURES

## AVENTINE



1. Air control
2. Spa-side control panel
3. Spa light
4. Filter compartment\*
5. Temperature sensor
6. Euro Directional jets
7. Euro-Pulse® jets
8. **ADAPTAFLO** jets
9. Outlet for optional ozone
10. Drain/suction fitting
11. Pillow
12. Grab Rail
13. **FROG**

**\* WARNING: DO NOT SIT IN THE  
FILTER COMPARTMENT AREA  
"THIS IS NOT A SEAT"!!!**

Sitting in this area can cause:

- Restriction of filter pump suction/vacuum.
- Damage to components.

Both can result in bodily harm.

Should damage occur to components in this area, replace immediately!

# JET MENUS

## PALATINO



### System 1

- 2 **ADAPTAFLO** Jets in back center
- **ACQUARELLA** Waterfall
- 4 Euro Jets in Lounge (calf area)
- 1 **ADAPTAFLO** Jet, 2 **ADAPTASSAGE** Jets and 4 Euro Jets in Lounge
- 2 Euro Jets and 1 **ADAPTAFLO** Jet in left center



### System 2

- 10 Euro Jets in back left
- 4 Euro Jets and 2 **ADAPTASSAGE** Jets in back right
- 2 **ADAPTAFLO** Jets and 1 Euro Jet in right center
- 4 Euro Jets in footwell

## MARINO



### System 1

- 8 Euro Jets in back left
- 2 **ADAPTAFLO** Jets in back center
- **ACQUARELLA** Waterfall
- 3 Euro Jets in center right
- 2 Euro Jets in footwell
- 2 Euro Jets and 1 **ADAPTAFLO** Jet in left center



### System 2

- 4 Euro Jets and 2 **ADAPTASSAGE** Jets in back right
- 4 Euro Jets in Lounge (calf area)
- 2 Euro Jets and 1 **ADAPTAFLO** Jet and 2 **ADAPTASSAGE** in Lounge
- 2 Euro Jets in footwell

# JET MENUS

## VANTO



### System 1

- 8 Euro Jets in back left
- **ACQUARELLA** Waterfall
- 3 Euro Jets in center right
- 6 Euro Jets and 1 **ADAPTAFLO** Jet in front right
- 4 Euro Jets in footwell



### System 2

- 2 **ADAPTAFLO** Jets in back center
- 4 Euro Jets and 2 **ADAPTASSAGE** Jets in back right
- 2 Euro Jets, 2 **ADAPTAFLO** Jet and 1 **ADAPTASSAGE** in front left

## TARINO



### System 1 Menu A (Diverter in position)

- 8 Euro Jets in back left
- 2 **ADAPTASSAGE** Jets in back right (Lounge)
- **ACQUARELLA** Waterfall
- 2 Euro Jets in footwell
- 3 Euro Jets and 2 **ADAPTASSAGE** Jet in front left (Lounge)



### System 1 Menu B (Diverter in position)

- 8 Euro Jets in back left
- 1 **ADAPTAFLO** Jet in back center
- **ACQUARELLA** Waterfall
- 4 Euro Jets in Lounge (calf area)
- 3 Euro Jets and 2 **ADAPTASSAGE** Jets in front left (Lounge)
- 1 **ADAPTAFLO** Jet in left center



# JET MENUS

## AVENTINE



### System 1

- 2 Euro Jets in back left
- 3 **ADAPTAFLO** Jets in back left
- 2 **EURO-PULSE** Jets in arm rests
- 4 Euro Jets in back right
- 2 **ADAPTAFLO** Jets in back right
- 1 **ADAPTAFLO** Jet in front right

# OPERATING INSTRUCTIONS

## CONTROL OPERATION

Your control panel consists of an LCD display and convenient touch pads that allow you to set the water temperature and adjust the skim/filter cycle settings, lock spa temp, lock entire spa functions, as well as control the hydrotherapy jets, and lights from spa-side.

### LCD DISPLAY

The LCD display on your spa-side control panel continually shows the spa's actual water temperature (Home screen). In certain situations, it will also display other messages. See TROUBLESHOOTING section.

### MODE BUTTON

From the Home screen use the **MODE** (▲ or ▼) button to scroll to the System, Clean, Audio (if your spa is equipped) and Tools screen. Press the (+) button to enter into the sub screens.

### TEMPERATURE CONTROL



The set temperature range is from 80°F (26°C) to 104°F (40°C). Temperatures of any setting may rise slightly depending on the current use and condition of your spa, and on outside temperature. The factory-set temperature is 100°F (38°C). Whenever power is disconnected and then reconnected to the spa, the water temperature setting will automatically return to the last temperature entered into the program.

To increase the set temperature, press the (+) button, once for each degree of increase temperature desired. If you hold the (+) button down, the set temperature will increase by one degree every half second.

To decrease the set temperature, press the (-) button, once for each degree of decreased temperature desired. If you hold the (-) button down, the set temperature will decrease by one degree every half second. When the spa water has reached the set temperature, the "READY" icon will display.



### JET PUMP CONTROL

Pressing the "JETS" button changes the jet pump functions, depending on the number of presses:

#### PALATINO, MARINO & VANTO Spa Models only:

- 1st press: System 1 jet pump runs on low speed
- 2nd press: System 1 jet pump runs on high speed
- 3rd press: System 1 & System 2 jet pumps run on high speed
- 4th press: System 2 jet pump runs on high speed
- 5th press: Both Systems jet pumps are off

#### TARINO & AVENTINE Spa Model only:

- 1st press: System 1 jet pump runs on low speed
- 2nd press: System 1 jet pump runs on high speed
- 3rd press: Jet pump off

- The pump on high speed automatically turns off after operating for one hour. The pump on low speed automatically turns off after operating for one hour.
- When the jets are active, the JETS icon on the control panel will illuminate.



### LIGHT ON/OFF & INTENSITY CONTROLS

The light control uses four positions: High, Medium, Low, and Off. To turn on the spa light, press the LIGHT button. This will place all lights in the spa in the High, or maximum intensity position. When the lights turn on, the light symbol will also illuminate on the control panel display. Press the LIGHT button again to lower the intensity of the lights to the Medium position. Press the LIGHT button again to lower the intensity even more, placing the lights intensity in the Low position. Press the LIGHT button one more time to shut the lights off. When the light is deactivated, the light symbol will also turn off.

If the lights are left on, they will automatically be turned off by the control system after 6 hours of continuous operation. The light symbol on the panel will also turn off when the lights are deactivated.

If the lights will not turn on, make sure SPA LOCK is deactivated. SPA LOCK disables the controls on the control panel (see following pages for more information on SPA LOCK).

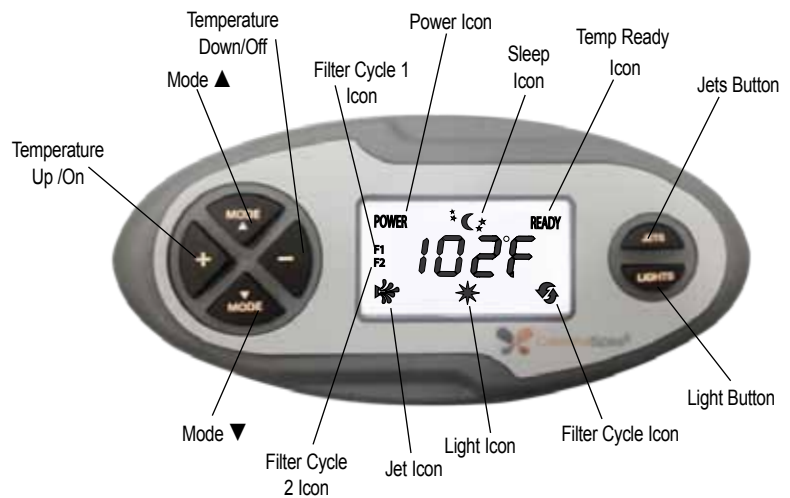

# OPERATING INSTRUCTIONS

## SYSTEM MODE

Your spa is equipped with a System Mode. This function will allow you to conveniently turn the jet(s) on high speed and the light on maximum intensity at the same time.

To activate the system mode, perform the following functions:

Press the MODE (▲ or ▼) button until SYSON is displayed on the screen. Press the (+) button to activate the SYSON mode feature. The jets and light icons will be illuminated on the display until the system mode is deactivated.

**NOTE:** Once activated, the jet and light functions can still be changed by pressing the JETS or LIGHT button.

To deactivate the system mode, press the MODE (▲ or ▼) button until the SYSON symbol is illuminated on the display. Press the (-) button to deactivate.



## MANUAL CLEAN CYCLE

All spas are equipped with a "Cleaning" mode. When the mode is activated, the jet pump in the first jet system will turn on and run for ten minutes (used for water maintenance). To activate the "Cleaning" mode, press the MODE (▲ or ▼) button several times until the CLEAN menu is displayed. Press the (+) button to activate the CLEAN mode feature.

**NOTE:** The jet icon will flash on and off while the "Cleaning" mode is active.

To stop the Cleaning Cycle before the ten minutes is complete, Press the MODE (▲ or ▼) button several times until the CLEAN menu is illuminated then press the (-) button to deactivate.

**NOTE:** Pressing the JETS button will also deactivate the clean cycle and the jet icon will remain on and solid.



## TOOLS MENU

The TOOLS menu is one of the main menus on the control panel. Within the TOOLS menu are seven submenus, which consists of: Temp Lock, Spa Lock, Light, Econ or Summer Timer, Filter 1, Filter 2, LCD and Exit.

To enter into the TOOLS menu, scroll through the main menus using the MODE (▲ or ▼) button until the TOOLS menu is displayed. Press the (+) button to enter into the TOOLS submenu, use the MODE (▲ or ▼) button to scroll through the submenus. Once the desired submenu is displayed, press the (+) button to activate the submenu. To leave the TOOLS submenu, scroll through the submenu until EXIT is displayed, press the (+) button to exit the submenu.

## LOCK FEATURES

The two locking features, SPA LOCK and TEMPERATURE LOCK, are enabled from the control panel by pressing the MODE (▲ or ▼) button until the TOOLS menu is displayed. Then press the (+) button to enter the TOOLS submenus. Use the MODE (▲ or ▼) button to scroll through the submenus to get to the locking features. Once enabled, a lock will remain active until the specific button combination is applied to disable the lock. Even if power is disconnected from the spa and soon thereafter reapplied (such as in a power outage) the lock will remain in place.

### TEMPERATURE LOCK

The TEMPERATURE LOCK feature deactivates the temperature control function of the control panel. TEMPERATURE LOCK is most often used by people who do not want others to tamper with or change the set temperature of the spa water. TEMPERATURE LOCK is a submenu of the TOOLS menu.

To activate the TEMPERATURE LOCK, press the MODE (▲ or ▼) button in the TOOLS submenu until the TLOK- symbol is displayed on the screen. Press the (+) button to activate the TEMPERATURE LOCK feature (TLOK+).

When the TEMPERATURE LOCK is activated, the JETS, LIGHT and any other features your spa may have will operate normally, and the temperature setting can be viewed but can NOT be changed. If a temperature button is pressed, TLOK will display for several seconds, then turns off.

To deactivate the TEMPERATURE LOCK, press the MODE (▲ or ▼) button in the TOOLS submenu until the TLOK+ symbol is illuminated on the display. Press the (-) button to deactivate the TEMPERATURE LOCK feature.

### SPA LOCK

The SPA LOCK feature deactivates all of the functions of the control panel. It is generally used to prevent unwanted use of the spa. The SPA LOCK menu is a submenu of the TOOLS menu.

To activate the SPA LOCK, press the MODE (▲ or ▼) button in the TOOLS submenu until SLOK- is displayed on the screen. Press the (+) button to activate the SPA LOCK feature.

When the SPA LOCK is activated, the buttons for the jets, temperature control, light, and any other features your spa may have are deactivated. If Jets, Light button, or (+) or (-) button is pressed, the SLOK will display for several seconds, then turns off.

To deactivate the SPA LOCK, press the MODE (▲ or ▼) button in the TOOLS submenu until the SLOK+ symbol is illuminated on the display. Press the (-) button to deactivate the SPA LOCK feature.

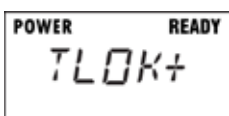

# OPERATING INSTRUCTIONS

## LOCK OVERRIDE

The Lock Override feature is for spa users who normally keep the set temperature locked. Should the user wish to lock all spa controls temporarily, the spa lock can be applied over an already-applied temperature lock. Then, when the spa lock is removed, the temperature lock will remain on to prevent unwanted tampering with the set temperature.

## LIGHT - MULTI-COLOR MENU CONTROLS (PALATINO, MARINO, VANTO & TARINO)

Your spa lights can display a variety of different colors as well as run through a continuous sequence of colors (loop) at different speeds. To activate this function the following is required:

Press the MODE (▲ or ▼) button to scroll to the TOOLS screen. Once displayed, press the (+) button to enter the TOOLS submenu. Press the MODE (▲ or ▼) button to scroll to LIGHT screen, press the (+) button to enter DIM screen. Press the (+) button or (-) button in the DIM screen to adjust the brightness of the lights. Press the MODE (▲) button to scroll to Color screen. Press the (+) button or (-) button in the COLOR screen as many times as desired to toggle through the different light colors. Press the MODE (▲) button to scroll to Loop screen. Press the (+) button or (-) button in the LOOP screen to select a continuous sequence of colors, the higher the loop number the faster the color sequence will run. Press the MODE (▲) button to scroll to EXIT screen. Press the (+) button in the EXIT screen to exit the LIGHT menu.

If the light is turned off while in the LOOP or COLOR mode, the same mode will exist when the light is reactivated. You will see a flashing light icon whenever your LOOP mode and light are turned on.



## SLEEP MODE

The Sleep Mode operation is a feature that minimizes pump operation during quiet evening hours. For example, if Filter Cycle 1 (F1) is set to activate at 8:00 a.m., by default, Filter Cycle 2 (F2) will activate at 8:00 p.m. (12 hours later). During 8:00 p.m. to 8:00 a.m., if the spa should call for heat, the pump and heater will activate to heat the spa under normal temperature demand. However, when in Sleep Mode, should the spa call for heat, the pump and heater will be suspended after Filter Cycle 2 (F2) until the activation of Filter Cycle 1 (F1), at 8:00 a.m. to minimize pump activation during quiet evening hours.

**Important:** Power-up of the spa starts the F1 sequence. In order for the sleep mode to work in the evening hours, the spa must be powered up in the early morning hours. The Sleep Mode will always be active the 6-12 hours between the end of (F2) and the beginning of (F1) depending on how the filter cycle program is set.

**Note:** If temperature drops below 80° F (27° C), heater will automatically activate to prevent spa from freezing.

To activate Sleep Mode feature:

- Press the MODE (▲ or ▼) button until the TOOLS screen is displayed.
- Press the (+) button to enter the TOOLS submenus.
- Press the MODE (▲ or ▼) button until ECON is displayed.
- Press the (+) button to activate Sleep Mode. Moon & Stars icon will appear on the screen of the control panel, indicating this feature has been activated.



To deactivate this feature, simply repeat steps A-C then press the (-) button.



## FILTER CYCLES

When the spa is first powered up, the automatic filter cycle will wait 10 minutes before starting. Your spa will automatically turn the first filter cycle on for 60 minutes on low speed. The second filter cycle will activate for 30 minutes, 12 hours later. The filter cycle icon, F1 or F2 will be displayed in the control panel during the filter cycle.

**NOTE:** The optional FRESHWATER III ozone system only works during the filter cycle.

To modify the length of either filter cycle:

- Press the MODE (▲ or ▼) button until the TOOLS menu is displayed.
- Press the (+) button to enter the TOOLS submenus.
- Press the MODE (▲ or ▼) button until FILT1 or FILT2 is displayed.
- Press the (+) button to enter FILT1 or FILT2. F1 or F2 icon will flash.
- Using the (+) or the (-) button, adjust the desired filter cycle time, from 0 to 6 hours.

The filter cycle will activate the jet pump on low speed for the entire cycle. When activated, the filter cycle icon on the display is turned on. If the temperature exceeds the set point by three degrees F for more than three hours, the system will cancel the filter cycle for the remaining filter cycle time. Should the temperature cool down to 1.5 degrees F (1 degree C) below the set point before the end of the cycle, the cycle will resume for the rest of the time. Should you use the spa during the filter cycle by placing the jet pump on high speed, the Filter icon and Jets icon will be on. Once the jet pump has been shut off, a ten minute tranquil mode begins (Filter & Jet icons are off during tranquil mode while F1 or F2 remain lit). The Filter and Jet icons will come back on once the tranquil mode ends if the filter cycle timer is still on.

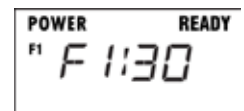

# OPERATING INSTRUCTIONS

## AUDIO MENU (OPTIONAL)

The following applies to spas that have an optional wireless music system installed:

When the wireless music system has been installed on the spa, the control panel can be used to manage the various music functions. The following information demonstrates how to navigate the audio menu by using the spa's control panel.

### AUDIO MENU

Once the music system is installed, an AUDIO menu will be accessible on the control panel screen. To access the menu, press the MODE (▲ or ▼) button until AUDIO is displayed.



### BASIC CONTROL PANEL OPERATION

- To enter into a sub-menu press the (+) button.
- To move to the next menu press the MODE (▲) button
- To exit from any sub-menu, press MODE (▲ or ▼) button as many times as necessary until EXIT is displayed then press the (+) button to exit that sub-menu.

### TO TURN AUDIO SYSTEM ON/OFF

From the AUDIO screen:

1. Press the (+) button to display POWER -.
2. Press the (+) button to display POWR + and turn the audio system ON. Press the (-) button to display PWR - and turn the audio system OFF.

**IMPORTANT:** The power can take a few seconds to turn on or off.

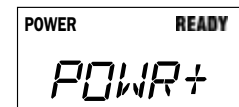

### TO ADJUST VOLUME

From the AUDIO screen:

1. Press the (+) button to display POWR.
2. Press the MODE (▲) button to display VOL.
3. Press the (+) button to increase volume and the (-) button to decrease volume.

NOTE: Volume range is from 0-40. No number displayed indicates Volume is OFF.

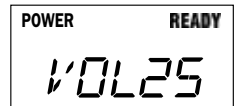

### TO PAUSE/PLAY (SONG)

From the AUDIO screen:

1. Press the (+) button to display POWR.
2. Press the MODE (▲) button to display VOL.
3. Press the MODE (▲) button to display PLAY.
4. Press the (+) button to start the song or the (-) button to pause the song.

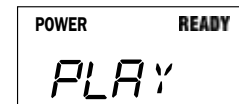

### TO CHANGE TRACK (SONG)

From the AUDIO screen:

1. Press the (+) button to display POWR.
2. Press the MODE (▲) button to display VOL.
3. Press the MODE (▲) button to display PLAY.
4. Press the MODE (▲) button to display TRCK +.
5. Press either (+) button or (-) button to change the track (song).



### TO GO TO SETUP MENU

From the AUDIO screen:

1. Press the (+) button to display POWR.
2. Press the MODE (▲) button to display VOL.
3. Press the MODE (▲) button to display PLAY.
4. Press the MODE (▲) button to display TRCK +.
5. Press the MODE (▲) button to display SETUP.



# OPERATING INSTRUCTIONS

## TO CHANGE AUDIO SOURCE

From the SETUP screen:

1. Press the (+)button to display one of four audio sources, IPOD,TV, AUX, BLUE.
2. Press the (+)button to raise to the next source or press the (-)button to lower to the next source. Go to the source you will be using.

NOTE: Blue = Bluetooth®. To use the Bluetooth screen, your audio Bluetooth device must be paired with the spa. On your device, find My Spa. If you do not see this on your device you may be too far away from spa or your Audio Source is not set to BLUE. Pair your device and you will be ready to use the Bluetooth. Audio must be On to use Bluetooth. Only one paired Bluetooth device will work at a time.

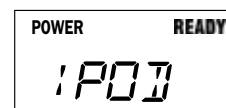

## TO ADJUST TREBLE

From the SETUP screen:

1. Press the (+)button to display one of four audio sources, IPOD,TV, AUX, BLUE.
2. Press the MODE (▲) button to display TRE -5 to +5.
3. Press (+)button to raise the Treble or press (-)button to lower the treble.

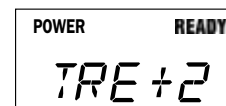

## TO ADJUST BASS

From the SETUP screen:

1. Press the (+)button to display one of four audio sources, IPOD,TV, AUX, BLUE.
2. Press the MODE (▲) button to display TRE.
3. Press the MODE (▲) button to display BAS -5 to +5.
4. Press (+)button to raise the Bass or press (-)button to lower the Bass.



## TO ADJUST BALANCE

From the SETUP screen:

1. Press the (+)button to display one of four audio sources, IPOD,TV, AUX, BLUE.
2. Press the MODE (▲) button to display TRE.
3. Press the MODE (▲) button to display BAS.
4. Press the MODE (▲) button to display BAL -5 to +5.
5. Press (+)button to raise the Balance # or press (-)button to lower the Balance #.



## TO ADJUST SUBWOOFER

From the SETUP screen:

1. Press the (+)button to display one of four audio sources, IPOD,TV, AUX, BLUE.
2. Press the MODE (▲) button to display TRE.
3. Press the MODE (▲) button to display BAS.
4. Press the MODE (▲) button to display BAL.
5. Press the MODE (▲) button to display SUB 0 to 11.
6. Press (+)button to raise the subwoofer # or press (-)button to lower the subwoofer #.

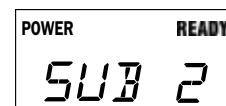

## TO CHANGE AMPLIFIER CHANNEL (TO MATCH WIRELESS DOCK TRANSMITTER INSIDE HOUSE IF INSTALLED)

From the SETUP screen:

1. Press the (+)button to display one of four audio sources, IPOD,TV, AUX, BLUE.
2. Press the MODE (▲) button to display TRE.
3. Press the MODE (▲) button to display BAS.
4. Press the MODE (▲) button to display BAL.
5. Press the MODE (▲) button to display SUB.
6. Press the MODE (▲) button to display CHAN 1-5.
7. Press (+)button to raise the channel # or press (-)button to lower the channel #.



NOTE: Channel number must match Transmitter number inside house to work properly

# OPERATING INSTRUCTIONS

## BRIGHTNESS - LCD

If you would like to change the brightness of the Control Panel screen:

- A. Press the MODE(▲ or ▼) button until the TOOLS menu is displayed.
- B. Press the (+)button to enter the TOOLS submenus.
- C. Press the MODE(▲ or ▼) button until LCD is displayed.
- D. Press the (+)button to enter into the LCD menu.
- E. Using the (+) or the (-) button, adjust the desired screen brightness.

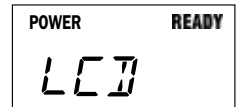

## AIR CONTROL

The Air Control(s) located next to your spa-side control panel allows you to change the power of the jets by regulating the amount of air that is mixed with the water coming out of the jets.

## HYDROTHERAPY JETS

**ADAPTAFLO** Jets – The larger jets in your spa allow you to re-direct the jet stream by changing the position of the nozzle.

You can also regulate the force of the massage by rotating the jet face to increase or decrease the force. Notice that turning off the flow to some jets increases the flow to the other jets. To avoid damage to your spa's plumbing and components, **do not turn off more than half of these jets at the same time.**

**ADAPTASSAGE** Jets – These jets provide a rotating massage pattern.

Euro Jets – The Euro Directional jets, with eyeball nozzles, deliver a direct, more focused massage. The **EURO-PULSE** jet features a special insert that creates a soft, pulsating, rotary massage.

## WATERFALL VALVE

The **PALATINO, MARINO, VANTO & TARINO** spas are equipped with a cascading waterfall feature. It is activated by pressing "JETS" button up to 3 times and turning the valve, located on the front interior wall, counterclockwise. The flow is regulated by turning the waterfall valve to the desired position.

**NOTE:** There is no lighting for this waterfall.

## DISPLAY INVERSION

You may invert the control panel display for easier viewing from inside the spa.

To invert the display the following is required:

Press the MODE(▼) and (-)buttons simultaneously. By pressing the MODE(▼) and (-)buttons simultaneously a second time the screen will go back to it's original display.

# WATER QUALITY AND MAINTENANCE

## WATER TERMINOLOGY

The following chemical terms are used in this Water Quality and Maintenance section. Understanding their meaning will help you to better understand the water maintenance process.

**Bromamines:** Compounds formed when bromine combines with nitrogen from body oils, urine, perspiration, etc. Unlike chloramines, bromamines have no pungent odor and are effective sanitizers.

**Bromine:** A halogen sanitizer that is commonly used in stick, tablet, or granular form. The **FROG** sanitizing system is the only solid bromine-approved system. See the DO's and DON'Ts of Spa Water Maintenance for additional information.

**Calcium Hardness:** The amount of dissolved calcium in the spa water. This should be approximately 50-150ppm. High levels of calcium can cause cloudy water and scaling. Low levels can cause harm to the spa equipment.

**Chloramines:** Compounds formed when chlorine combines with nitrogen from body oils, urine, perspiration, etc. Chloramines can cause eye irritation as well as having a strong odor. Unlike bromamines, chloramines are weaker, slower sanitizers.

**Chlorine:** An efficient sanitizing chemical for spas. Watkins Manufacturing Corporation recommends the use of sodium dichlor-type granulated chlorine. This type is preferred because it is totally soluble and nearly pH neutral.

**Chlorine (or Bromine) Residual:** The amount of chlorine or bromine remaining after chlorine or bromine demand has been satisfied. The residual is, therefore, the amount of sanitizer which is chemically available to kill bacteria, viruses and algae.

**Corrosion:** The gradual wearing away of metal spa parts, usually caused by chemical action. Generally, corrosion is caused by low pH or by water with levels of TA, CH, pH or sanitizer which are outside the recommended ranges.

**DPD:** The preferred reagent used in test kits to measure the Free Available Chlorine (FAC).

**Halogen:** Any one of these five elements: fluorine, chlorine, bromine, iodine, and astatine.

**MPS:** Monopersulfate is a non-chlorine oxidizer.

**Oxidizer:** The use of an oxidizing chemical is to prevent the buildup of contaminants, maximize sanitizer efficiency, minimize combined chlorine and improve water clarity.

**Ozone:** Ozone is a powerful oxidizing agent which is produced in nature and artificially by man. Ozone forms no by-products of chloramines (ozone actually oxidizes chloramines) and will not alter the water's pH.

**Pathogen:** A microorganism such as bacterium that cause disease.

**pH:** The measure of the spa water's acidity and alkalinity. The recommended pH for the spa water is 7.2 to 7.8. Below 7.0 (considered neutral), the spa water is too acidic and can damage the heating system. Above 7.8, the water is too alkaline and can result in cloudy water, and scale formation on the shell and heater.

**ppm:** The abbreviation of "parts per million", the standard measurement of chemical concentration in water. Identical to mg/l (milligrams per liter).

**Reagent:** A chemical material in liquid, powder, or tablet form for use in chemical testing.

**Sanitizer:** Sanitizers are added and maintained at recommended residuals to protect bathers against pathogenic organisms which can cause disease and infection in spa water.

**Scale:** Rough calcium-bearing deposits that can coat spa surfaces, heaters, plumbing lines and clog filters. Generally, scaling is caused by mineral content combined with high pH. Additionally, scale forms more readily at higher water temperatures.

**Shock Treatment:** Also known as "super-chlorination" when chlorine is used. Shock treatment is a process of adding significant doses of a quick dissolving sanitizer (sodium dichlor is recommended) to oxidize non-filterable organic waste and to remove chloramines and bromamines.

**Total Alkalinity:** The amount of bicarbonates, carbonates, and hydroxides present in spa water. Proper total alkalinity is important for pH control. If the TA is too high, the pH is difficult to adjust. If the TA is too low, the pH will be difficult to hold at the proper level. The desired range of TA in spa water is 40 to 120 ppm.

## GENERAL INFORMATION

### THE THREE FUNDAMENTAL AREAS OF WATER MAINTENANCE:

- **Water Filtration**
- **Chemical Balance/pH Control**
- **Water Sanitation**

Water sanitation is the responsibility of the spa owner. To properly sanitize the spa, Watkins highly recommends the **FROG** water care system. This system will chemically control the bacteria and viruses present in the fill water or introduced during use of the spa. Bacteria and viruses can grow quickly in undersanitized spa water.

The water's chemical balance and pH control are also the responsibility of the spa owner. You'll have to add chemicals to maintain proper levels of Total Alkalinity (TA), Calcium Hardness (CH) and pH. Proper water balance and pH control will minimize scale buildup, extend the life of the spa, and allow the sanitizer to work at an optimum level.



# WATER QUALITY AND MAINTENANCE

## METHODS FOR TESTING THE SPA WATER

Accurate water testing and analysis is an important part of effectively managing your spa water. You must have the ability to test for:

- Total Alkalinity (TA)
- Calcium Hardness (CH)
- pH
- Sanitizer

Two types of testing methods are recognized and recommended by Watkins Manufacturing Corporation:

1. **The Reagent Test Kit** is a method which provides a high level of accuracy. The reagents come in either liquid or tablet form.
2. **Test Strips** are a convenient testing method used by many spa owners. Keep in mind that test strips are susceptible to heat and moisture contamination, which will result in inaccurate readings.

Always read and carefully follow the directions included with the Test Kit or Test Strips to ensure the accuracy of the test results.

## BASIC CHEMICAL SAFETY

When using chemicals, read the labels carefully and follow directions precisely. Though chemicals protect you and your spa when used correctly, they can be hazardous in concentrated form. Always observe the following guidelines:

- Allow only a responsible person to handle spa chemicals. **KEEP THEM OUT OF THE REACH OF CHILDREN.**
- Accurately measure the exact quantities specified, never more. Do not overdose your spa.
- Handle all containers with care. Store in a cool, dry, well ventilated place.
- Always replace the caps on their proper containers when not in use.
- Don't inhale fumes or allow chemicals to come in contact with your eyes, nose, or mouth. Wash your hands immediately after use.
- Follow the emergency advice on the product label in case of accidental contact, or if the chemical is swallowed. Call a doctor or the local Poison Control Center. If a doctor is needed, take the product container along with you so that the substance can be identified.
- Don't let chemicals get on surrounding surfaces or landscaping.
- Don't use a vacuum cleaner to clean up chemical spills.
- Never smoke around chemicals. Some fumes can be highly flammable.
- Don't store any chemicals in the spa equipment compartment.

## HOW TO ADD CHEMICALS TO THE SPA WATER

**IMPORTANT:** All spa water chemicals (other than **FROG** cartridges), including MPS Plus (shock), chlorine, granulated pH increaser or decreaser, granulated total alkalinity increaser, calcium hardness increaser, liquid stain and scale inhibitor, and liquid de-foamer must always be added directly into or in front of the filter compartment while a jet pump is running, and it must run for a minimum of ten minutes.

### To Administer Spa Water Chemicals:

1. Fold back the cover.
2. Carefully measure the recommended amount of chemical and slowly pour it over the filter basket area while in the Clean cycle. Use care not to splash chemicals on your hands, in your eyes, on the spa sheet surface, or on the siding.
3. After ten minutes your jet pump will shut off, close the spa cover. **Risk of Drowning:** Never leave an open spa unattended!

⚠ **WARNING:** High sanitizer levels can cause discomfort to the user's eyes, lungs and skin. Always allow the sanitizer level to fall to the recommended range before using the spa.

**IMPORTANT "SUPER CHLORINATION/NON-CHLORINE SHOCK TREATMENT" NOTE:** After administering a super chlorination treatment or non-chlorine shock to your spa, leave the cover open for a minimum of 20 minutes to allow the oxidizer gas to vent. A high concentration of trapped oxidizer gas which may exist as a result of the shock treatment (not daily sanitation) may eventually cause discoloration or vinyl degradation to the bottom of the cover. This type of damage is considered chemical abuse and is not covered under the terms of the limited warranty.

# WATER QUALITY AND MAINTENANCE

## THE WATKINS SPA WATER MAINTENANCE PROGRAM

Each step in your water maintenance program is dependent on the completion of the previous steps. Omitting a step or failing to reach the recommended range may cause an imbalance in your water's chemistry. Unbalanced water chemistry can damage the spa and its components, as well as cause discomfort for the user.

### BALANCING THE TOTAL ALKALINITY (TA)

- The recommended Total Alkalinity (TA) for your spa water is 40 - 120 ppm.
- Total Alkalinity is a measure of the total levels of carbonates, bicarbonates, hydroxides, and other alkaline substances in the water. TA is referred to as the water's "pH buffer". In other words, it's a measure of the ability of the water to resist changes in pH level.
- If the TA is too low, the pH level will fluctuate widely from high to low. Fluctuations in pH can cause corrosion or scaling of the spa components. **Low TA can be corrected by adding sodium hydrogen carbonate (MONARCH pH/Alkalinity Up).**
- If the Total Alkalinity is too high, the pH level will tend to be high and may be difficult to bring down. **It can be lowered by using sodium bisulfate (MONARCH pH/Alkalinity down)**
- Once the TA is balanced, it normally remains stable, although the addition of more water with a high or low alkalinity will raise or lower the TA reading of the water.
- When the Total Alkalinity is within the recommended range, proceed to the next step.

### BALANCING THE CALCIUM HARDNESS (CH)

- The recommended Calcium Hardness (CH) level for your spa is 50 - 150 ppm.
- Calcium Hardness is a measure of the total amount of dissolved calcium in the water. Calcium helps control the corrosive nature of the spa's water. That's why calcium-low water (commonly known as "soft" water) is not recommended. It is very corrosive to the equipment, and can cause staining of the spa shell.
- If the CH is too high (commonly known as "hard water"), formation of scale on the spa's shell surface and equipment can result. **CH can be decreased by dilution-a mixture of 75% hard and 25% soft water will usually yield a reading within the correct range.** If soft water is not available or practical for you, a stain and scale inhibitor should be added to the spa water, according to label instructions.
- If the CH is too low add **MONARCH CH Increaser**.
- Once the CH is balanced, it normally remains stable, although the addition of more water with a high or low calcium content will raise or lower the CH reading of the water.
- When the Calcium Hardness is within the recommended range, proceed to the next step.

### BALANCING THE pH

- The recommended pH level for your spa water is 7.2 - 7.8.
- The pH level is the measure of acidity and alkalinity. Values above 7.8 are alkaline; those below 7.2 are acidic. Maintaining the proper pH level is extremely important for:
  - Optimizing the effectiveness of the sanitizer.
  - Maintaining water that is comfortable for the user.
  - Preventing equipment deterioration.
- If the spa water's pH level is too low, the following may result:
  - The sanitizer will dissipate rapidly.
  - The water may become irritating to spa users.
  - The spa's equipment may corrode.

**If the pH is too low, it can be increased by adding sodium hydrogen carbonate (MONARCH pH/Alkalinity Up) to the spa water**

- If the pH level is too high, the following may result:
  - The sanitizer is less effective.
  - Scale will form on the spa shell surface and the equipment.
  - The water may become cloudy.
  - The filter cartridge pores may become obstructed.

**If the pH is too high, it can be decreased by adding sodium bisulfate (MONARCH pH/Alkalinity Down) to the spa water**

**NOTE:** After adding sodium hydrogen carbonate or sodium bisulfate, before testing the water for pH. Measurements taken too soon may not be accurate.

- It is important to check the pH on a regular (weekly) basis. The pH will be affected by the bather load, the addition of new water, the addition of various chemicals, and the type of sanitizer used. When the pH is within the recommended range, proceed to the final step.

ALKALINE SPA WATER (SCALING ZONE)	8.2	ADD pH DECREASER TO LOWER pH
	7.8	
COMFORT ZONE	7.6	IDEAL
	7.4	
	7.2	
ACIDIC SPA WATER (CORROSIVE ZONE)	6.8	ADD pH INCREASER TO RAISE pH
	pH	

# WATER QUALITY AND MAINTENANCE

## MAINTAINING THE SANITIZER LEVEL

- A. Sanitizer is extremely important for killing algae, bacteria and viruses, and preventing unwanted organisms from growing in the spa. At the same time, you don't want too high a sanitizer level, or it can irritate your skin, lungs, and eyes.
- B. Always maintain the sanitizer level in your spa at the recommended level for each type of sanitizer.
- C. Watkins recommends the following sanitizer:
  - **FROG** sanitizing system (mineral and bromine).
- D. Watkins also approves the following sanitizers:
  - Sodium Dichloro-s-Triazinetrione (sodium dichlor or chlorine)
  - Biguanide
  - Bromine

THE WATKINS WATER MAINTENANCE QUICK REFERENCE GUIDE					
Steps	Ideal Range (ppm)		What Chemicals to Use		
	Minimum	Maximum	To Raise	To Lower	
1 Total Alkalinity	40	120	Sodium Hydrogen Carbonate, or Sodium Bicarbonate	Sodium Bisulfate	
2 Calcium Hardness	50	150	Calcium Hardness Increaser	Use a mixture of 75% hard water and 25% soft water or use a Stain and Scale Inhibitor	
3 pH	7.2	7.8	Sodium Hydrogen Carbonate	Sodium Bisulfate	
4 Sanitizer	See section on Maintaining the Sanitizer Level				

⚠ **WARNING:** DO NOT use tri-chlor chlorine or any type of compressed bromine or chlorine, acid or any type of sanitizer which is not recommended by Watkins Manufacturing Corporation.

## FROG WATER CARE SYSTEM

*(THE FROG MINERAL CARTRIDGE IS NOT APPROVED FOR USE IN CANADA.)*

The **FROG** Water Care system is comprised of the following products:

**THE FROG MINERAL CARTRIDGE.** This cartridge introduces minerals into the spa water, inhibiting bacteria growth.

**THE FROG BROMINE CARTRIDGE (BCDMH).** The only recommended sanitizer that will work in conjunction with the **FROG** Mineral cartridge.

**IMPORTANT:** In addition to regularly testing and balancing your spa water, a weekly "shock treatment" is required. The shock treatment quickly destroys any remaining contaminants while revitalizing the bromine in the water.

To weekly "shock treat" your spa, we recommend that you use either **MONARCH** MPS Plus or sodium dichlor (chlorine). Sodium dichlor may be a more appropriate weekly shock for those users that experience heavy bather load conditions.

The following optional products can be used in conjunction with the **FROG** Water Care system:

**MONARCH MPS PLUS NON-CHLORINE SHOCK (MPS/Monopersulfate)** is an oxidizing chemical used to prevent the buildup of contaminants, maximize sanitizer efficiency, and improve water clarity. When used in conjunction with the **FROG** system it oxidizes particulates in the spa water.

**IMPORTANT NOTE:** **MONARCH** MPS Plus is an oxidizer, not a sanitizer.

**MONARCH CHLORINE** is an efficient sanitizing chemical for spas and can be used for the required weekly "shock treatment" when using the **FROG** water care system. Watkins Manufacturing Corporation recommends the use of sodium dichlor-type granulated chlorine because it is totally soluble and nearly pH neutral.

**MONARCH CORONA DISCHARGE (CD) OZONE** is a high output ozone system and is the only ozone purification system approved for installation in your **CALDERA** Spa. The **MONARCH** ozone system utilizes CD technology to produce a **higher concentration of ozone than is produced by a competing** chip style CD or ultraviolet light ozone systems.

# WATER QUALITY AND MAINTENANCE

**NOTE:** Refer to the Start-Up instructions on page 7 or your FROG owner's manual for start-up and operation instructions. The owner's manual can be found with your FROG starter kit.

It is important to follow the recommended application and maintenance programs outlined for each product's use. If the spa is being used over an extended period or time, such as a whole afternoon or evening, additional sanitizer will be needed.

**NOTE:** The FROG Mineral Cartridge is not approved for use in Canada.

**NOTE:** For Canada, if you are only using the bromine cartridge, your bromine levels should be between 3.0 - 5.0 ppm.

## FROG CARTRIDGE REPLACEMENT INSTRUCTIONS

The FROG bromine cartridge should be replaced every 2-4 weeks, depending on User Load. The FROG mineral cartridge should be replaced every 4 months. When replacing the mineral cartridge, it is highly recommended that the spa be drained and refilled at the same time. After refilling the spa with water and spa has reached operating temperature, balance the Total Alkalinity (TA), Calcium Hardness (CH) and pH to the recommended levels. Shock the spa by adding MONARCH MPS Plus non-chlorine shock or sodium dichlor (chlorine), then replace the cartridges.

To replace FROG cartridges, follow these steps:

1. Turn off power to the spa
2. Unscrew FROG cap on top edge of spa
3. Turn handle counter-clockwise
4. Lift cartridge holder up and out of spa
5. Remove and discard old cartridges
6. Turn top cap of new Mineral cartridge to setting #6 for 24 hours, then set to #2
7. Turn top cap of new Bromine cartridge to setting #6 for 24 hours, then set to #2
8. Snap bromine cartridge into the bottom of holder and snap mineral cartridge into the top  
**IMPORTANT:** It is important that the bromine cartridge is on the bottom; otherwise, the bromine cartridge could dispense prematurely.
9. Reinstall cartridge holder into spa, push down, and twist clockwise.
10. Replace FROG cap
11. Reconnect power to the spa

**IMPORTANT NOTE:** Adjust bromine cartridge setting down by one setting each day until a residual of 1.0 - 2.0 ppm level of bromine is established

⚠ **WARNING:** High sanitizer levels can cause discomfort to the user's eyes, lungs and skin. Always allow the sanitizer level to fall to the recommended range before using the spa.

## FOLLOWING THE FROG SANITIZER ROUTINE

During the first month of ownership, measure the sanitizer residual daily in order to establish the correct setting on cartridges for User Load and Usage Time versus Sanitizer Needed.

- **USER LOAD** is the number of times anyone enters the spa.
- **USAGE TIME** is simply the amount of time a user spends in the spa.
- **Sanitizer Needed** is the amount needed to accommodate the number of users and their combined usage time.

For example, two spa users who regularly use the spa once an evening for twenty minutes create a specific and somewhat consistent demand on the sanitizer. During the first month of ownership, these two users can determine exactly how much sanitizer to use in order to maintain the proper residual. If, at any time, the user load and/or usage pattern changes dramatically (i.e. invited guests), the amount and frequency of sanitizer required increases dramatically. The greater the usage time, or the bather load, the faster the residual value is diminished.

## BROMINE

- A. Sanitizing chemicals, such as bromine, are oxidants that kill bacteria and viruses in the water. If you are using the FROG system, the recommended bromine level for your spa water is 1.0 - 2.0 ppm. If you are not using the FROG system, your bromine level should be between 3.0 - 5.0 ppm. **NOTE:** For Canada, if you are only using the bromine cartridge, your bromine levels should be between 3.0 - 5.0 ppm.
- B. When not using the FROG system Watkins Manufacturing Corporation recommends the use of granulated bromine for sanitizing the water. Granulated bromine is preferred because it is totally soluble, dissolves quickly and is nearly pH neutral.
- C. Maintaining the proper level of bromine during use is extremely important.
- D. If the bromine level is too low, bacteria and viruses can grow rapidly in the warm water.
- E. If the bromine level is too high, the water can cause discomfort to the user's eyes, lungs and skin. **Simply allow some time to pass in order for the bromine to dissipate.**
- F. When the bromine level is within the recommended range, the spa is ready to be enjoyed.

## DO'S AND DON'TS

- **DO** check your bromine chemical level prior to each use.
- **DO** change the FROG mineral cartridge every 4 months.
- **DO** test Total Alkalinity and pH weekly.
- **Do** use MONARCH chlorine.
- **DO** use MONARCH MPS or MPS+ non-chlorine (monopersulfate) oxidizer for spa only.
- **DO** store all chemicals in a tightly sealed container in a cool, dry place.
- **DON'T** use sodium bromide or biguanides. These are an active sanitizer and will combine with the silver ions to inactivate them.

# WATER QUALITY AND MAINTENANCE

- **DON'T use a water clarifier; Clarifiers will cause the spa water to become cloudy.**
- **DON'T use the MONARCH silver cartridge with FROG.**

## CHLORINE (SODIUM DICHLOR) (USE MONARCH CHLORINE)

- Sanitizing chemicals, such as chlorine, are oxidants that kill bacteria and viruses in the water. The Free Available Chlorine (FAC) is a measure of the amount of unused chlorine available to sanitize the spa. The recommended FAC for your spa water is 3.0-5.0 ppm.
- Watkins Manufacturing Corporation recommends the use of sodium dichlor type granulated chlorine for sanitizing the water. Sodium dichlor is preferred because it is totally soluble, dissolves quickly and is nearly pH neutral.
- Maintaining the proper level of chlorine during use is extremely important.
- If the FAC is too low, bacteria and viruses can grow rapidly in the warm water. Increase the FAC by adding granulated sodium dichlor.
- If the FAC is too high, the water can cause discomfort to the user's eyes, lungs and skin. Simply allow some time to pass. The FAC level will drop naturally over time.
- When the Free Available Chlorine is within the recommended range, the spa is ready to be enjoyed.

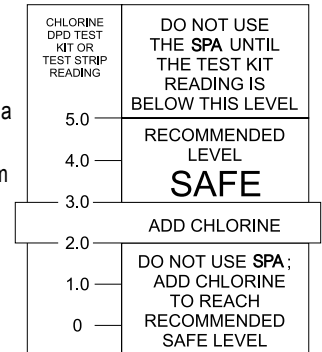

WATKINS WATER TREATMENT GUIDE	
<b>At spa startup or refill</b>	Follow spa Start-Up and Refill Procedures.
<b>Prior to each use</b> <small>(Test before adding any chemicals; do not add any chemicals if proper or higher levels are found.)</small>	Add one-half (½) teaspoon of <b>MONARCH</b> sodium dichlor per 250 gallons, <b>OR</b> Add one (1) tablespoon <b>MONARCH</b> MPS Plus (monopersulfate)* per 250 gallons
<b>Once a week</b>	Add one-half (½) teaspoon of <b>MONARCH</b> sodium dichlor per 250 gallons, <b>OR</b> Add four (4) tablespoons <b>MONARCH</b> MPS Plus (monopersulfate)* per 250 gallons
<b>Every four months</b>	Drain and refill your spa. Follow spa Start-Up and Refill Procedures.
<b>As needed</b> <small>(If water is hazy, cloudy or has an odor)</small>	Add one and one half (1-1/2) teaspoons of sodium dichlor per 250-gallons, as needed.

\*MONARCH MPS and MPS Plus is an oxidizer, not a sanitizer

## SUPER CHLORINATION

Super Chlorination is a process used to eliminate chlorine smell (if you are using chlorine) by "burning-off" chloramines (used chlorine). This helps maintain the proper level of free chlorine.

When giving your water a super chlorination treatment, open the cover at least half way for twenty minutes to allow the chlorine gas to vent off. The high concentration of chlorine gas which may exist as a result of super chlorination (not daily sanitation) may eventually cause discoloration or degradation to the bottom of the cover, which would not be covered under the terms of your warranty.

**⚠ WARNING:** There are several forms of stabilized chlorine available for use in spas and swimming pools. Each form has specific chemical characteristics. It is extremely important that the form you choose is specifically designed for use in spas. Use of an incorrect product such as tri-chloro, which has a very low pH (2.6), dissolves too quickly in hot water resulting in extremely high levels of chlorine, and is designed for concrete or plaster swimming pools, WILL cause damage to your spa. Use of a liquid, or any type of compressed bromine or chlorine, acid, or any type or sanitizer which is not recommended by Watkins Manufacturing Corporation, WILL damage your spa and is specifically not covered under the terms of the limited warranty.

**IMPORTANT:** Granulated chlorine (sodium dichlor) will degrade if stored improperly. We recommend purchasing chlorine in one, two, or five pound containers and storing it in a cool, dry place to maintain its potency.

**⚠ WARNING:** Never leave an open spa unattended, especially if there are children present!

## SUPPLEMENTAL WATER MAINTENANCE

Proper water sanitation and mineral balance (pH control) are absolutely essential for a complete spa water maintenance program. Here are two other popular water additives that are optional:

### 1. Mineral Deposit Inhibitors (USE MONARCH STAIN/SCALE)

As water evaporates from your spa and new water is added, the amount of dissolved minerals will increase. (Minimize evaporation by keeping the cover on the spa whenever possible.) The spa water may eventually become "hard" (Calcium Hardness too high) enough to damage the heater by calcifying its surface. Proper pH control can minimize this.

# WATER QUALITY AND MAINTENANCE

Normal soap build-up will require water replacement regularly enough that mineral deposits normally are not a problem.

Occasionally, high iron or copper content in the water may produce green or brown stains on the spa. A stain and scale inhibitor may help to reduce these metals.

**NOTE:** Well water may contain high concentrations of minerals. The use of a low water volume, extra-fine pore water filter will help to remove many of the larger particles during the filling of the spa.

## 2. Foam Inhibitors (USE MONARCH DEFOMER)

Spa water requires changing due to the buildup of soap in the water. Typically, soap will cause the spa water to foam when the jets are used. Soap is introduced into the spa water from two sources: users' bodies, which retain a soap residue after showering, and swimming apparel, which retains soap after washing.

Foam inhibitors can suppress foam, but cannot remove soap from the water. Soap is very difficult to remove from the water because soap is not oxidized by any chemical added to the spa. Only ozone can oxidize soap.

Eventually the soap build-up in the water will be concentrated, resulting in an unclean feeling on the bather's skin, which is impossible to remedy. When this occurs, it's time to drain and refill the spa. Depending on the soap input, the water should last about 4 months before needing to be drained.

## MONARCH OZONE SYSTEM (OPTIONAL)

The **MONARCH** high output ozone system is the only ozone purification system approved for installation in your **VACANZA** series spa. The **MONARCH** ozone system utilizes Corona Discharge (CD) technology to produce a higher concentration of ozone than is produced by competing ultraviolet light (UV) ozone systems.

The **MONARCH** high output ozone system greatly enhances the quality of the spa water when used to supplement the spa owner's regular water maintenance program. Contrary to some information circulated throughout the pool and spa industry regarding ozone systems, ozone can not be used as a single-source sanitizer, water clarifier, anti-foamer, and mineral chelating agent. Watkins Manufacturing Corporation recommends following the **FROG** sanitizing system when using an ozone purification system to assure water sanitation and the highest quality of purified water.

### Cleaning the Ozone Injector

On occasion, a mineral build up may clog the ozone injector, causing a lack of flow or low flow, of ozone bubbles. To prevent this, refer to the following instructions to clean the injector:

1. Disconnect power to the spa.
2. Access the equipment compartment.
3. Place 16 ounces of white vinegar into a container such as a cup or bucket. Place the container on the equipment compartment floor. **NOTE:** White vinegar will not damage any of the spa components.
4. Carefully loosen the long tubing to the bottom of the ozonator. **A liquid substance may be found inside the tubing. If a liquid substance is present, BE CERTAIN NOT TO COME IN CONTACT WITH THE LIQUID (SEE WARNING BELOW).**



**Nitric acid accumulates in the air lines of the ozonator and injector. Nitric acid will cause severe chemical burns if direct skin contact is made, so always wear protective gloves, glasses and clothing when working on the ozonator or injector lines. To prevent inhalation or ingestion of the nitric acid, DO NOT blow or inhale with your mouth to any of the adapters, fittings or tubing of the ozonator or injector air lines.**



5. Place the end of the tubing into the vinegar, making certain that the end of the tubing sits at the bottom of the container.
6. Reconnect power to the spa.
7. Run the spa until all 16 ounces of the vinegar are gone. This should allow an ample flow of vinegar to be run through the injector and clear the blockage.
8. Disconnect power to the spa.
9. Remove the empty cup or bucket.
10. Reinstall the tubing to the bottom of the ozonator.
11. Close the equipment compartment door.
12. Reconnect power to the spa.

The **MONARCH** ozone system is practically maintenance-free because it is located within the spa's equipment compartment. If bubbles are appearing at the spa's heater return, but the water is not as clear as usual, then the operation of the ozone generator should be checked by your dealer.

**WARNING:** Contact your dealer if your spa requires troubleshooting beyond the scope of this manual. **MONARCH** ozone systems should only be serviced by a qualified technician.

**WARRANTY NOTE:** Cleaning of the ozone injector is not covered under the warranty. Refer to the Ozone section of this manual for ozone injector cleaning instructions..

# WATER QUALITY AND MAINTENANCE

## DO'S AND DON'TS

- **DO** add all chemicals slowly into or in front of the filter compartment with the jet pump operating for ten minutes.
- **DO** use special care if using baking soda to clean either the interior or exterior plastic surfaces.
- **DO** use only a granular form of bromine sanitizer.
- **DON'T** use swimming pool (muriatic) acid to lower pH.
- **DON'T** splash pH increaser additives on the siding.
- **DON'T** use Compressed Sanitizers.

The use of bromine sticks or tablets in floaters, which may become entrapped in a lounge or cooling seat (or sink to the spa floor), have been shown to cause discoloration of or surface distress to a spa's shell.

- **DON'T** use a floater type sanitization system as a low or no maintenance solution to your spa maintenance program.

Floating dispensers can become trapped in one area and cause an over-sanitization (or chemical burn) of that particular area.

If the dispenser setting is too high, the high concentration can discolor the spa shell and damage the underside of the cover.

Automatic floating dispensers have a tendency to either over-brominate or under-brominate as the rate of erosion varies greatly. Damage to the spa and cover can occur very quickly.

Watkins Manufacturing Corporation does not recommend the use of any floating chemical dispenser. Damage to the spa shell or components caused by a floating chemical dispenser is specifically not covered under the terms of the limited warranty.

- **DON'T** use a sanitizer which is not designed for spas.
- **DON'T** use household bleach (liquid sodium hypochlorite).
- **DON'T** broadcast or sprinkle the chemicals onto the water surface. This method may cause chemically-induced spa surface blistering (chemical abuse) very quickly.

<b>SPA WATER MAINTENANCE TROUBLESHOOTING GUIDE</b>		
<b>Problem</b>	<b>Probable causes</b>	<b>Solutions</b>
Cloudy Water	<ul style="list-style-type: none"> <li>• Dirty filters</li> <li>• Excessive oils / organic matter</li> <li>• Improper sanitization</li> <li>• Suspended particles / organic matter</li> <li>• Overused or old water</li> </ul>	<ul style="list-style-type: none"> <li>• Clean filters</li> <li>• Shock spa with sanitizer</li> <li>• Add sanitizer</li> <li>• Adjust pH and/or alkalinity to recommended range</li> <li>• Run jet pump(s) and clean filters</li> <li>• Drain and refill the spa</li> </ul>
Water Odor	<ul style="list-style-type: none"> <li>• Excessive organics in water</li> <li>• Improper sanitization</li> <li>• Low pH</li> </ul>	<ul style="list-style-type: none"> <li>• Shock spa with sanitizer</li> <li>• Add sanitizer</li> <li>• Adjust pH to recommended range</li> </ul>
Chlorine Odor	<ul style="list-style-type: none"> <li>• Chloramine level too high</li> <li>• Low pH</li> </ul>	<ul style="list-style-type: none"> <li>• Shock spa with sanitizer</li> <li>• Adjust pH to recommended range</li> </ul>
Musty Odor	<ul style="list-style-type: none"> <li>• Bacteria or algae growth</li> </ul>	<ul style="list-style-type: none"> <li>• Shock spa with sanitizer – if problem is visible or persistent, drain, clean and refill the spa</li> </ul>
Organic buildup / scum ring around spa	<ul style="list-style-type: none"> <li>• Buildup of oils and dirt</li> </ul>	<ul style="list-style-type: none"> <li>• Wipe off scum with clean rag – if severe, drain the spa, use a spa surface and tile cleaner to remove the scum and refill the spa</li> </ul>
Algae Growth	<ul style="list-style-type: none"> <li>• High pH</li> <li>• Low sanitizer level</li> </ul>	<ul style="list-style-type: none"> <li>• Shock spa with sanitizer and adjust pH</li> <li>• Shock spa with sanitizer and maintain sanitizer level</li> </ul>
Eye Irritation	<ul style="list-style-type: none"> <li>• Low pH</li> <li>• Low sanitizer level</li> </ul>	<ul style="list-style-type: none"> <li>• Adjust pH</li> <li>• Shock spa with sanitizer and maintain sanitizer level</li> </ul>
Skin Irritation / Rash	<ul style="list-style-type: none"> <li>• Unsanitary water</li> <li>• Free chlorine level above 5 ppm</li> </ul>	<ul style="list-style-type: none"> <li>• Shock spa with sanitizer and maintain sanitizer level</li> <li>• Allow free chlorine level to drop below 5 ppm before spa use</li> </ul>
Stains	<ul style="list-style-type: none"> <li>• Total alkalinity and/or pH too low</li> <li>• High iron or copper in source water</li> </ul>	<ul style="list-style-type: none"> <li>• Adjust total alkalinity and/or pH</li> <li>• Use a metal deposit inhibitor</li> </ul>
Scale	<ul style="list-style-type: none"> <li>• High calcium content in water – total alkalinity and pH too high</li> </ul>	<ul style="list-style-type: none"> <li>• Adjust total alkalinity and pH – if scale requires removal, drain the spa, scrub off the scale, refill the spa and balance the water</li> </ul>

# MAINTENANCE

## COMMON WATER CHEMISTRY QUESTIONS

**Question:** Why is the use of a floater not recommended to sanitize my spa water?

**Answer:** Watkins Manufacturing Corporation does not recommend the use of a floater for three reasons:

1. The floater is unable to control the rate at which the sanitizer is dissolved into the water. When a floater is first placed in a spa, the sanitizer level can be extremely high. High sanitizer levels can chemically burn or discolor the spa's shell or the underside of the cover. Then, after a period of time, the sanitizer level dispensed by the floater will fall to near zero. A low sanitizer level will allow viruses, bacteria or algae to grow.
2. Floaters tend to stay in one area of the spa most of the time, causing this area to be exposed to extreme sanitizer levels.
3. The floater may allow pieces of the highly concentrated sanitizer to fall out and settle on the floor or seat of the spa shell. These pieces of sanitizer will chemically burn (blister) the spa shell. Although your spa shell is specifically designed to resist the effects of spa chemicals, no spa surface can withstand this type of highly concentrated chemical. Remember, chemical abuse is specifically not covered under the terms of the warranty.

**Question:** When I open my spa, I smell chlorine. How do I get rid of this smell?

**Answer:** There are two types of chlorine in your spa. The first is the Free Available Chlorine, which is the chlorine available to sanitize your spa. This Free Available Chlorine does not have an odor. The second is Chloramine, which is residue from chlorine already expended. Chloramines have a strong chlorine odor. The smell from Chloramines can be eliminated by "shocking" the water. If you smell chlorine in the water, your spa is reminding you to add a shock treatment.

**Question:** Why can't I fill my spa with soft water?

**Answer:** Soft water is essentially the same as regular water, except that most or all of the calcium has been replaced by sodium. Soft water may be corrosive to the heater and other components. Replacement of spa components damaged by soft water is extremely expensive.

**Question:** I am trying to reduce the number of chemicals to which my family is exposed. Do I really need to use so many chemicals and in such large amounts?

**Answer:** While over-exposure to any chemical can be unhealthy, many low levels of chemicals are effective and beneficial. In the case of spa water, the chemicals recommended in the **CALDERA** Spa Water Maintenance program are needed to protect the user from water-borne pathogens (disease-causing microbes) and to prevent corrosion of spa components.

**Question:** Why isn't water chemistry damage covered by the warranty?

**Answer:** The chemical levels and water quality of the water in the spa are under your direct control. With proper basic care, the spa will provide many years of hot water relaxation. If you are unsure about any chemical or its usage in the spa, contact your Authorized **CALDERA** Dealer or Watkins Manufacturing Corporation.

## FILTER MAINTENANCE

At least once a week, check and clean the skimmer basket and weir to ensure proper filter flow. Remove leaves, foreign matter, and debris. It is very important to keep your spa filter cartridge clean and free of particles to ensure proper water flow. A clean filter permits the hydrotherapy system to function properly and also allows more efficient filter cycles. Depending on how frequently your spa is used, we recommend cleaning the spa filter cartridge every four weeks. If this is not done, the filter may clog and restrict water flow, which causes improper filtration and poor jet performance.

⚠ **WARNING:** The frequency and duration of use, and the number of occupants all contribute to determining the appropriate time between filter cleanings. More use means that more frequent filter cleanings will be required.

## FILTER CARTRIDGE REMOVAL AND CLEANING FOR PALATINO, MARINO, VANTO & TARINO SPA MODELS (USE MONARCH FILTER CLEANER)

1. Disconnect the spa from the power supply by turning the power to the spa OFF.
2. Remove any floating items from within the filter compartment.
3. Turn the filter retainer handle (located on the top of the filter cartridge) counterclockwise until the retainer can be removed from the filter standpipe.
4. Remove the filter retainer, cover and cartridge.  
**SERVICE NOTE:** Never remove the filter standpipe when debris is present in the filter compartment. Debris may find its way into the internal plumbing which may result in blockage. NEVER REMOVE SUCTION FITTINGS!
5. Always clean the filter using a filter degreaser, to remove mineral and oil build-up. Simply soak the filter in the degreaser according to the package directions, then place the filter on a clean surface and spray until clean using a garden hose. It may be necessary to rotate the filter while spraying to remove any debris lodged between the filter pleats.
6. To reinstall the filter cartridge, reverse the order of steps in which it was removed. Do not overtighten

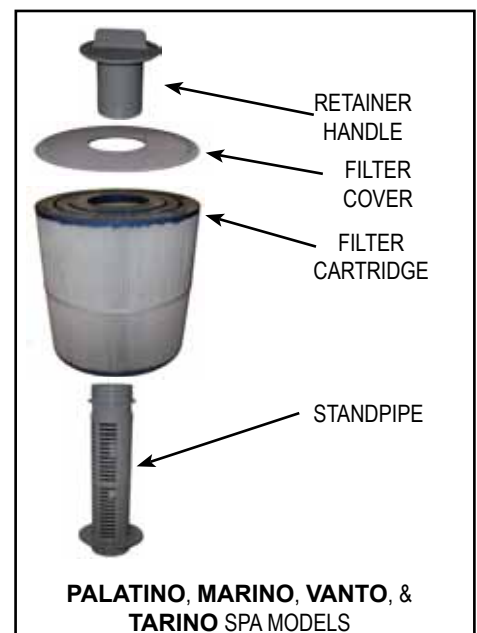



# MAINTENANCE

## FILTER CARTRIDGE REMOVAL AND CLEANING FOR AVENTINE SPA MODEL

(USE MONARCH FILTER CLEANER)

1. Turn the power to the spa OFF, then proceed as follows:
2. Push down slightly and turn filter basket counterclockwise to unlock, then pull the basket and weir out.
3. Carefully pull up the filter cartridge and bring it out of the spa.
4. Rinse cartridge using a garden hose. Rotate and separate filter pleats while spraying water to remove all debris possible. Let the filter dry and then look for calcium deposits (scaling) or an oil film. If you find these, you will need to deep clean your filter cartridge with a "spa filter cleaning" solution to break down and remove mineral deposits and oils.
5. Install filter then replace basket and weir by inserting and rotating clockwise to lock into position.

## CARE OF THE SPA PILLOWS

Spa pillows will provide years of comfort if treated with care. They have been positioned above the water level to minimize the bleaching effects of chlorinated water and other spa water chemicals. To extend their life, whenever the spa shell is being cleaned, the spa pillows should be removed and cleaned. Body oils can be removed with a mild soap and water solution. ALWAYS rinse off the spa pillows thoroughly to remove any soap residue. If the spa is not going to be used for a long period of time (that is during a vacation or if the spa is winterized), or when the spa water is being super-chlorinated, the spa pillows should be removed until the next use of the spa.

### To remove and replace the spa pillows:

1. Carefully lift one end of the pillow away from the spa shell.
2. Continue lifting one end until all pillow retainers are released from the pillow

**IMPORTANT:** Just pulling the pillow straight up and out of the shell recess will eventually damage the pillow. This abuse is not covered under warranty

3. To reinstall the spa pillow, carefully bend the pillow slightly to allow one of the pillow retainers to slip into the recess in the back of the pillow.
4. Keeping the pillow slightly bent, slide the other pillow retainer into the recess in the back of the pillow.
5. After all the pillow retainers are in place, press the pillow down into the recess in the spa shell.

## CARE OF THE EXTERIOR

### SPA SHELL

Stains and dirt generally will not adhere to your spa's surface. A soft rag or a nylon scrubber should easily remove most dirt. Always use a soft, non-abrasive solution (such as baking soda and water mix). Never use cleaners with harsh chemicals or acids, such as citrus, alcohol, or ammonia. Damage to your spa shell can occur. Always thoroughly rinse off any spa shell cleaning agent with fresh water.

### SERVICE NOTES:

1. Iron and copper in the water can stain the spa shell if allowed to go unchecked. Watkins recommends using **MONARCH** Stain/Scale if your spa water has a high concentration of dissolved minerals.
2. The use of alcohol or any household cleaners other than those listed to clean the spa shell surface is NOT recommended, Watkins recommends the use of **MONARCH** Spa Shine. DO NOT use any cleaning products containing abrasives or solvents since they may damage the shell surface. **NEVER USE HARSH CHEMICALS!** Damage to the shell by the use of harsh chemicals is not covered under the warranty.

**IMPORTANT:** Some surface cleaners contain eye and skin irritants. Keep all cleaners out of the reach of children and use care when applying.

## CARE OF THE SPA COVER

⚠ **WARNING:** The cover is a manual safety cover that meets or exceeds all prevailing requirements of ASTM Standards for spa safety covers when installed and used correctly as of the date of manufacture. Non-secured or improperly secured covers are a hazard. Open the cover to its fully open position before use.

### VINYL COVER

The vinyl spa cover is an attractive, durable foam insulation product. Monthly cleaning and conditioning are recommended to maintain its beauty.

### To clean and condition the vinyl cover:

1. With a garden hose, spray the cover to loosen and rinse away dirt or debris.

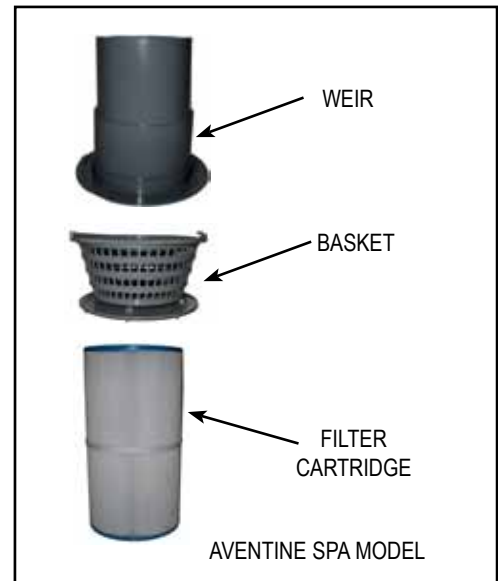

# MAINTENANCE

- Using a large sponge and/or a soft bristle brush, and using a very mild soap solution (1 teaspoon dishwashing liquid with 2 gallons of water) or baking soda (sodium bicarbonate), scrub the vinyl top in a circular motion. Do not let the vinyl dry with a soap film on it before it can be rinsed clean.
- Scrub the cover's perimeter and side flaps. Rinse clean with water.
- Rinse off the underside of the cover with water only (use no soap), and wipe it clean with a dry rag.  
**SERVICE NOTE:** To remove tree sap, use cigarette lighter fluid (not charcoal lighter fluid). Use sparingly, and rinse with a saddle soap solution immediately afterwards, then wipe dry.
- Use MONARCH Cover Shield to protect the cover.

## Important reminders:

- DO** remove snow buildup to avoid breakage of the foam core from the additional weight of the snow.
- DO** lock cover lock straps to secure the cover when the spa is not in use.
- DO NOT** drag or lift the spa cover using either the flaps or the cover lock straps.
- DO NOT** walk, stand, or sit on the cover.
- DO NOT** place any metal or heat transferring object on the cover or place any type of plastic tarp or drop cloth over the cover as this may result in a melted foam core, which would not be covered under the warranty.
- DO NOT** use any lifting mechanisms, chemicals or cleaners except those recommended by Watkins Manufacturing Corporation or its Authorized Sales and Service Dealer

## ECOTECH SPA CABINET

The **ECOTECH** cabinet consists of rigid polymers that combine the durability of plastic, with the beauty of wood. **ECOTECH** won't crack, peel, blister, or delaminate even after prolonged exposure to the elements.

Cleaning your **ECOTECH** cabinet is as easy as spraying the cabinet with a mild soap and water solution to remove any stains and residue.

## DRAINING YOUR SPA

- TURN OFF OR DISCONNECT POWER FROM THE SPA.**
- Locate the drain valve for the spa (lower front of the spa) and remove the drain cap. Attach the inlet of a garden hose to the drain valve (to avoid flooding of the foundation surrounding the spa) and route the outlet of the hose to an appropriate draining area. Spa water with a high sanitizer level may harm plants and grass.
- Open the valve by turning the knob. The spa will drain by gravitational flow.  
**IMPORTANT:** All **VACANZA** spa models will drain almost completely through the main drain valve. Equipment such as the jet pump and heating system will drain. Any water remaining within the plumbing or equipment after draining will only need to be removed if the spa is being winterized.
- After your spa is empty, clean the shell and filter cartridge.
- After cleaning, close the drain valve, remove garden hose and put drain cap back in place.

## NON-OPERATION IN COLD CLIMATE

If the spa is to be left unused for an extended period of time in areas where FREEZING TEMPERATURES DO NOT OCCUR, it may be desirable to turn the heater to the lowest temperature. The automatic filter cycles will keep the spa water clean and sparkling. When preparing the spa for use, check the water chemistry to assure correct chlorine or bromine and pH levels.

You can keep the water in the spa during the time of year when freezing at the spa location may occur. If a freeze condition is detected, the pump and heater will be activated automatically to circulate the water in low speed. However, CAUTION must be used with this approach. In the event of electrical power interruption, regardless of the cause, the heater and pump will stop operating and freeze protection will be lost, possibly resulting in freeze damage to the spa, spa plumbing and/or components. Such damage is not covered by warranty.

## WINTERIZING YOUR SPA

If the spa is located where freezing temperatures occur, and you do not intend to use your spa for an extended period, follow steps 1 through 7 outlined in "DRAINING YOUR SPA" then complete the steps below:

**IMPORTANT:** The following steps should protect your spa from freezing damage provided these instructions are followed exactly. For maximum protection against freeze damage to your spa, Watkins Manufacturing Corporation recommends contacting your local **CALDERA** dealer to schedule an in-home Propylene glycol (anti-freeze) Winterizing Service plan.

**NOTE: MAKE CERTAIN ALL POWER TO THE SPA IS OFF** and all water has been drained from the spa before you continue.

- It will be necessary to remove all water from the interior plumbing.

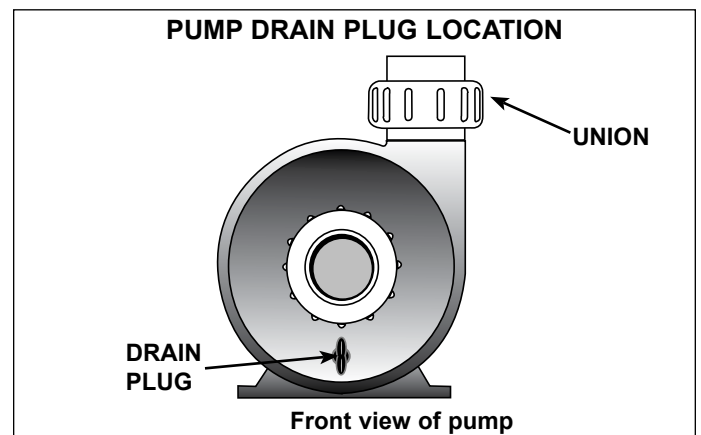

# MAINTENANCE

2. Remove the floating weir, basket, and filter cartridge. Clean the filter cartridge and store in a dry place. Attach the vacuum hose to the **vacuum side** of the shop vac and thoroughly dry the filter compartment.
3. Using the shop vac, remove the water starting with the jets at the top and moving to the ones at the bottom of the spa.  
**NOTE:** When removing the water from jet openings, you may notice suction coming from another jet. With the help of a second person, block off any suction from the other jet using a large rag or cloth. This will help pull out the water that is trapped deep inside the main line.
4. Thoroughly dry the spa shell with a clean towel.
5. Using a funnel, pour Propylene glycol anti-freeze into the filter suction fittings and jet outlets. Add enough anti-freeze until the liquid starts to come out of the bottom drain.  
**CAUTION:** Use only Propylene glycol as your anti-freeze. This is non-toxic. NEVER use automobile anti-freeze since it is toxic.
6. Close the spa cover and fasten the cover tie downs. If your area receives a lot of snow or ice, it is recommended to cover the spa cover with two pieces of plywood forming a pitched roof top to prevent snow and ice build-up. Secure a plastic sheet or tarp over the spa cover and one over the plywood.  
**WARNING:** When not in use, the spa must be covered with an insulating spa cover. Damage caused by either sun exposure or freezing is not covered under warranty.
7. In the pump side of the equipment control bay, remove the pump drain plug located on the front of the pump housings. Allow all water to drain out. Place the drain plug in a reclosable plastic storage bag and store near the pump. Replace the drain plugs on start-up. (Refer to the Figure above)
8. Unscrew the suction/discharge pump and heater unions and allow the water to drain. Leave union loose. **NOTE:** Tighten unions before filling spa.
9. Replace the equipment and pump doors and secure with screws.

## OPENING INSTRUCTIONS:

1. Remove plywood and plastic sheet. Open the spa cover by unfastening the cover tie downs.
2. Follow the Start-up and Refill Procedures in the Operating Instructions section of the Owner's Manual. Do not install filters to prevent them from exposure to the anti-freeze.
3. As part of this process, superchlorinate the spa water by adding three teaspoons of chlorine (sodium dichlor) per 250 gallons of spa water into the filter compartment. This is twice the normal amount of chlorine needed for superchlorination. This extra amount of chlorine is needed to destroy the anti-freeze.  
**NOTE:** A defoamer may be needed to decrease the amount of foam caused by the anti-freeze.
4. Drain your spa to ensure removal of anti-freeze. Do not drain water on grass or plants due to excessive chlorine level.
5. After the spa has completely drained, re-install your filter and follow the Start-up and Refill Procedures in the Operating Instructions section of the Owner's Manual.  
**IMPORTANT:** Always keep spa covered when not in use, whether it is empty or full.

## ACTS INVALIDATING WARRANTY

The limited warranty is void if the **CALDERA** spa has been improperly installed, subjected to alteration, misuse, or abuse, or if any repairs on the spa are attempted by anyone other than an authorized representative of Watkins Manufacturing Corporation. Alteration shall include any component or plumbing change, electrical conversion, or the addition of any non-approved sanitation or water purification device or heating system which contributes to component or unit failure or unsafe operating system. Misuse and abuse shall include any operation of the spa other than in accordance with Watkins Manufacturing Corporation printed instructions, or use of the spa in an application for which it is not designed; specifically: use of the spa in a non-residential application; damage caused by operation\* of the spa at water temperatures outside the range of 35°F and 120 °F; damage caused by a dirty, clogged or calcified filter cartridge; damage to the spa surface caused by the use of tri-chloro chlorine, BCDMH, misuse of chemical tablets in a floater, acid, or any other spa chemicals or spa surface cleaners which are not recommended by Watkins Manufacturing Corporation; damage caused by allowing undissolved spa sanitizing chemicals to lie on the spa surface (no spa surface material can withstand this kind of abuse); damage to components or spa surface caused by improper water chemistry maintenance; and damage to the spa surface caused by leaving the spa uncovered while empty of water and in direct exposure to sunlight (this may cause solar heating distress in warm weather regions). These are considered abuses and may invalidate this warranty.

\*Operation of the spa does not mean "use" of the spa! Watkins Manufacturing Corporation does not recommend using the spa if the water temperature is above or below the spa's control panel temperature range.

## DISCLAIMERS

Watkins Manufacturing Corporation shall not be liable for loss of use of the **VACANZA** series spa or other incidental or consequential costs, expenses or damages, which may include but are not limited to, the removal of a permanent deck or other custom fixture. Any implied warranty shall have a duration equal to the duration of the applicable warranty stated above. Under no circumstances shall Watkins Manufacturing Corporation or any of its representatives be held liable for injury to any person or damage to any property, however arising.

## WATKINS CUSTOMER SERVICE

If you have any questions about any aspect of your **VACANZA** series spa set-up, operation or maintenance that have not been answered by this manual, consult your **CALDERA** dealer.

Watkins Manufacturing Corporation can be reached at: 800-669-1881 (Extension 8432), Monday through Friday, 8 am to 5-pm Pacific Standard Time (PST), or e-mail at [custsvc@watkinsmfg.com](mailto:custsvc@watkinsmfg.com).

# SPA TROUBLESHOOTING

## TROUBLESHOOTING

If your spa doesn't seem to be working the way you believe it should, please review the "START-UP" and "OPERATION" instructions in this manual. If this doesn't help you correct the problem, follow the appropriate instructions below. If the problem still is not resolved, call your **CALDERA** dealer.

GENERAL OPERATION TROUBLESHOOTING GUIDE		
Problem	Probable causes	Solutions
Entire spa is inoperative.	<ul style="list-style-type: none"> <li>Power failure / not plugged in</li> <li>GFCI tripped</li> </ul>	<ul style="list-style-type: none"> <li>Check power source</li> <li>Reset GFCI; call for service if it will not reset.</li> </ul>
Spa does not heat; jets and light operate. Display shows "====" POWER & READY icon flashes	<ul style="list-style-type: none"> <li>Pressure switch is open and should be closed</li> <li>Pressure switch senses flow through heater even though the jet pump is off</li> </ul>	<ul style="list-style-type: none"> <li>Check for clogged filter. The pressure switch will reset when the flow of water through the heater has been restored. Call for service if the pressure switch trips frequently.</li> <li>Contact an Authorized Service Technician</li> </ul>
READY icon flashes	<ul style="list-style-type: none"> <li>Control Sensor open or shorted</li> </ul>	<ul style="list-style-type: none"> <li>Contact an Authorized Service Technician</li> </ul>
Spa does not heat; jets and light operate. Display shows "-----" POWER & READY icon flashes	<ul style="list-style-type: none"> <li>Pressure switch is closed and should be open</li> </ul>	<ul style="list-style-type: none"> <li>Contact an Authorized Service Technician</li> </ul>
Jets weak or surging	<ul style="list-style-type: none"> <li>Spa water level too low</li> <li>Filters clogged / suction screens clogged</li> <li>Jet nozzles closed / Air valve closed</li> </ul>	<ul style="list-style-type: none"> <li>Add water</li> <li>Clean filters / Clean suction screens</li> <li>Open jet nozzles / Open air valve</li> </ul>
Light inoperative	<ul style="list-style-type: none"> <li>Bad connection</li> </ul>	<ul style="list-style-type: none"> <li>Contact an Authorized Service Technician</li> </ul>
Display shows "- - - -" (Entire spa is inoperative.) POWER icon flashes	<ul style="list-style-type: none"> <li>Heater high limit thermostat tripped</li> </ul>	<ul style="list-style-type: none"> <li>Disconnect power to the spa for at least thirty seconds to reset the heater high-limit. If tripping continues, clean the filter, then if tripping still occurs, call for service.</li> </ul>
After filling or refilling the spa: a jet pump is operating, but water is not flowing from any of its jets.	<ul style="list-style-type: none"> <li>Pump is not properly primed.</li> </ul>	<ol style="list-style-type: none"> <li>Turn off power to the spa at the breaker and remove the equipment compartment door</li> <li>Loosen the union on the top of the pump(s) (as seen on page 34) to allow the air to escape, then hand-tighten the union(s).</li> <li>Turn power back on, activate the pump and check to make sure union is tight enough to keep it from leaking. Re-install pump and equipment doors.</li> </ol> <p>OR:</p> <ul style="list-style-type: none"> <li>Remove and reinstall the <b>FROG</b> cap.</li> </ul>

# SPA TROUBLESHOOTING

## PRIMING THE PUMP(S)

Upon filling or refilling the spa, if a pump is operating and water is not flowing from any of its jets, the pump may not be properly primed. To correct, refer to the illustration below and perform the following procedures:

- Turn off power to the spa at the breaker and remove the equipment compartment door.
- **Loosen** the union on the top of the pump(s) to allow the air to escape. When water is present, hand-tighten the union.
- Turn power back on, activate the pump and check to make sure union is tight enough to keep it from leaking. Re-install equipment door.

**NOTE:** Equipment compartment illustrated below will vary depending on spa model.

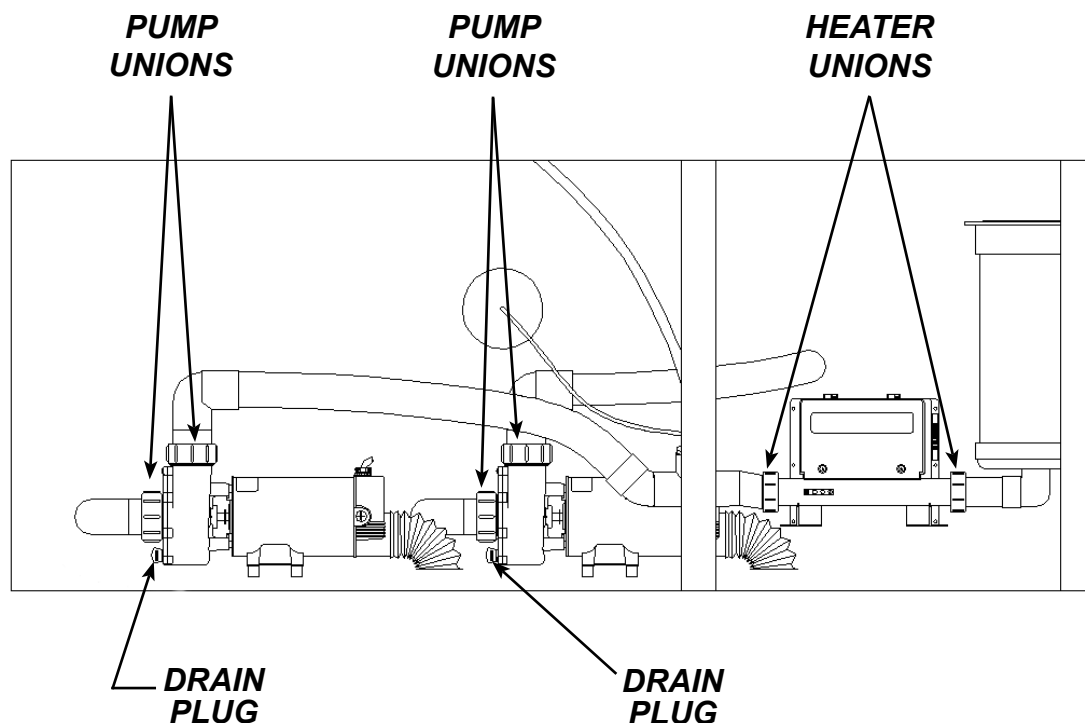

### **IMPORTANT**

**THE DRAIN PLUG AND UNION FITTINGS IN THE EQUIPMENT COMPARTMENT MAY LOOSEN DURING TRANSPORTATION. TO AVOID LEAKS, PLEASE CHECK TO MAKE SURE THESE ARE HAND-TIGHT PRIOR TO FILLING YOUR SPA.**

# Vacanza® Series

## Limited Warranty

Watkins Manufacturing Corporation (“Watkins”) warrants to the original consumer purchaser (“you”) the following about your new Palatino®, Marino®, Vanto®, Tarino® or Aventine®, Vacanza Series spa, when purchased from an authorized dealer/service provider (“dealer”).

### 5 YEAR NO LEAK SHELL WARRANTY

Watkins warrants against water loss due to defects in the spa shell for five years.

### 2 YEAR SHELL SURFACE WARRANTY

Watkins warrants the acrylic surface material to be free from defects in material and workmanship for two years.

### 2 YEAR NO LEAK PLUMBING WARRANTY

Watkins warrants the Vacanza Series spas against leaks caused by defects in manufacturing and workmanship for two years. This warranty specifically covers leaks from the wall fittings, jet fittings, internal plumbing, internal glue joints, drains, hoses and all bonded parts.

### 2 YEAR COMPONENT WARRANTY

Watkins warrants the electrical components, pump(s), and other Vacanza Series spa components against defects in materials and workmanship for two years. Some parts, most of which can be changed out without the use of tools, such as filter cartridges, spa pillows, and cover locks are not included in this warranty, but are warranted to be free from defects in materials and workmanship at the time of delivery. Spa covers and other spa accessories are specifically excluded from this warranty, although they may be covered under other warranties. Please check with your Caldera dealer for details.

### 2 YEAR ECOTECH® CABINET WARRANTY

Watkins warrants the EcoTech simulated wood cabinet material to be free from defects in materials and workmanship for two years. This warranty specifically covers the cabinet’s structural integrity, including the material and assembly.

The EcoTech cosmetic finish is warranted to be free from defects in materials and workmanship at the time of initial delivery. Fading and weathering of the surface may naturally occur over time and are not considered defects. To restore the cabinet’s appearance, refer to the spa Owner’s Manual for proper care and maintenance instructions.

### 2 YEAR LED LIGHT ASSEMBLY WARRANTY – PALATINO, MARINO, VANTO, & TARINO SPAS

Watkins warrants the LED light assemblies of the Palatino and Marino, Vanto and Tarino spas, which consists of all lights within the spa, including the main light, to be free from defects in materials and workmanship for two years.

### 1 YEAR LED LIGHT ASSEMBLY WARRANTY – AVENTINE SPA

Watkins warrants the LED light assemblies of the Aventine spa, which consists of all lights within the spa, including the main light, to be free from defects in materials and workmanship for one year.

### 1 YEAR FROG® WARRANTY

Watkins warrants the FROG water care system in the Vacanza Series spas to be free from defects in materials and workmanship for one year.

The following applies to all of the warranties listed:

### EXTENT OF WARRANTY

This warranty extends only to the original consumer purchaser of the Caldera spa when purchased and originally installed within the boundaries of the United States. This warranty begins on your delivery date of the spa, but in no event later than one year from the date of purchase.

This warranty terminates upon any transfer of ownership, or if the spa is installed or relocated outside the boundaries of the United States by the original consumer purchaser prior to the expiration of the warranty period.

### WARRANTY PERFORMANCE

To make a claim under this warranty, contact your dealer. In the event you are unable to obtain service from the dealer, please contact Watkins Manufacturing Corporation at 1280 Park Center Drive, Vista, California, 92081, Attn: Customer Service Department (800) 669-1881 or via e-mail, [custsvc@watkinsmfg.com](mailto:custsvc@watkinsmfg.com). You must give Watkins and/or your dealer written notice of any warranty claim, along with a copy of your original purchase receipt indicating the date of the purchase, within ten (10) days of the time you discover the claim. Watkins reserves the right to inspect the malfunction or defect on location.

Watkins or its Authorized Service Agent will repair any defects covered by this warranty. Except as described herein, you will not be charged for parts, labor or the freight costs for parts necessary to repair the spa for defects covered by this warranty. In some cases, the servicing dealer may charge you a reasonable repairperson travel/service charge that is not covered by this warranty. Please contact the dealer for information regarding any such charges.

### LIMITATIONS

Except as described above, this warranty does not cover defects or damage due to normal wear and tear, improper installation, alteration without Watkins’ prior written consent, accident, acts of God, misuse, abuse, commercial or industrial use, use of an accessory not approved by Watkins, failure to follow Watkins’ Pre-Delivery Instructions or Owner’s Manual, or repairs made or attempted by anyone other than an authorized representative of Watkins. Alteration includes, but is not limited to, any component or plumbing change, or electrical conversion. Visit [www.calderaspas.com](http://www.calderaspas.com) or contact your dealer for a list of manufacturer approved accessories.

### DISCLAIMERS

**TO THE EXTENT PERMITTED BY LAW, WATKINS SHALL NOT BE LIABLE FOR LOSS OF USE OF THE SPA OR OTHER INCIDENTAL OR CONSEQUENTIAL COSTS, EXPENSES, OR DAMAGES, INCLUDING BUT NOT LIMITED TO THE REMOVAL OF ANY DECK OR CUSTOM FIXTURE OR ANY COST TO REMOVE OR REINSTALL THE SPA, IF NEEDED.** Some states do not allow the exclusion or limitation of incidental or consequential damages, so the above limitations may not apply to you. **ANY IMPLIED WARRANTIES, INCLUDING THE IMPLIED WARRANTIES OF MERCHANTABILITY AND FITNESS FOR A PARTICULAR PURPOSE, ARE LIMITED TO THE DURATION OF THE APPLICABLE WARRANTY STATED ABOVE.** Some states do not allow limitations on how long an implied warranty may last, so the above limitations may not apply to you.

### LEGAL REMEDIES

This warranty gives you specific legal rights, and you may have other rights which vary from state to state.



# VACANZA SERIES SPA SPECIFICATIONS

	Footprint dimensions	Height	Effective filter area	Heater (Watts)	Water capacity	Dry weight	Filled weight*	Dead weight*	Electrical requirements
<b>PALATINO</b> (Model PLT)	7'5" x 7'5"	38"	65 square feet	4,000	400 gallons	911 lbs.	5,297 lbs.	120 lbs. per Square foot	230 volt, 30 or 50 amp Single phase GFCI circuit
<b>MARINO</b> (Model MRN)	7'0" x 7'0"	36"	65 square feet	4,000	360 gallons	836 lbs.	4,888 lbs.	120 lbs. per Square foot	230 volt, 30 or 50 amp Single phase GFCI circuit
<b>VANTO</b> (Model VNT)	7'0" x 7'0"	36"	65 square feet	4,000	375 gallons	847 lbs.	5,200 lbs.	125 lbs. per Square foot	230 volt, 30 or 50 amp Single phase GFCI circuit
<b>TARINO</b> (Model TAR)	6'10" x 6'10"	33"	30 square feet	1,000 or 4,000	340 gallons	705 lbs.	4,636 lbs.	115 lbs. per Square foot	115 volt, 20 amp Dedicated GFCI protected cord or 230 volt, 30 or 50 amp Single phase GFCI circuit
<b>AVENTINE</b> (Model AVH)	5'5" x 5'5"	29"	35 square feet	1,000 or 4,000	150 gallons	501 lbs.	2,102 lbs.	105 lbs. per Square foot	115 volt, 20 amp Dedicated GFCI protected cord or 230 volt, 30 or 50 amp Single phase GFCI circuit

**CAUTION:** Watkins Manufacturing Corporation suggests a structural engineer or contractor be consulted before the spa is placed on an elevated deck.

\* **NOTE:** The "Filled weight" and "Dead weight" of the spa includes the weight of the occupants (assuming an average occupant weight of 175 lbs).



©2014 Watkins Manufacturing Corporation. Caldera spas, Vacanza, Palatino, Marino, Tarino, Vanto, Aventine, Monarch, EcoTech, Mystique, Euro-Pulse, AdaptaFlo, AdaptaSsage, and The Home Relaxation Specialists are trademarks of Watkins Manufacturing Corporation. BaquaSpa is a trademark of Arch UK Biocides, Limited Inc. FROG® is a registered trademark of King Technology.



**Watkins**  
The Home Relaxation Specialists

Watkins Manufacturing Corporation  
Vista, California  
USA

calderaspas.com

303765.15 A (12/14)